

Marina table

© design by Metrica

extremis®



Dimensions

The Marina high table with two legs is available in 4 lengths and 2 widths

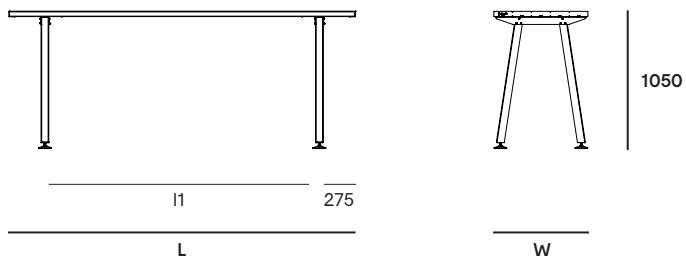

Dimensions (mm)	L	W 5 prof	W 6 prof	l1
Marina high table 195	1950	720	870	1400
Marina high table 265	2650	720	870	2100
Marina high table 335	3350	720	870	2800
Marina high table 405	4050	720	870	3500

The Marina high table with three legs is available in 4 lengths and 2 widths

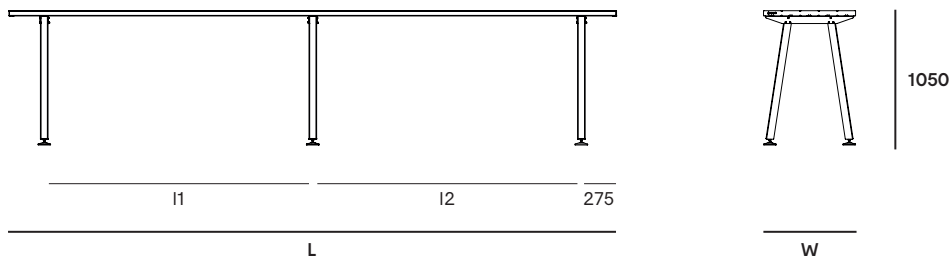

Dimensions (mm)	L	W 5 prof	W 6 prof	l1	l2
Marina table 475	4750	720	870	2100	2100
Marina table 545	5450	720	870	2800	2100
Marina table 615	6150	720	870	2800	2800
Marina table 685	6850	720	870	3500	2800

Box dimensions - Marina high table 2 legs

The Marina high table comes in 3 or 4 boxes

Box 1: 3 profiles

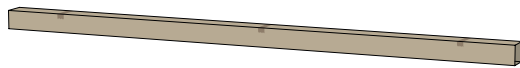

Box 2: 2 profiles



Box 3: Set high table legs + mounting kit



Box 4: Endcaps (+ reinforcement profiles) + mounting kit



Box dimensions (mm)		L	W	H	Qty	Volume (m ³)	Gross weight (kg)	Net weight (kg)	Packaging weight (kg)	
Marina high table 195	Box 1	2030	140	120	1	0,03	17,20	15,70	1,50	
	Tabletop width 720 mm	Box 2	2030	140	80	1	0,02	11,40	10,50	0,90
		Box 3	870	145	75	2	0,02	13,30	11,70	1,60
		Box 4	870	145	75	1	0,01	2,39	2,05	0,34
					Total:	0,08	44,29	39,95	4,34	
Marina high table 195	Box 1	2030	140	120	2	0,07	34,40	31,40	3,00	
	Tabletop width 870 mm	Box 3	870	145	75	2	0,02	18,88	17,28	1,60
		Box 4	870	145	75	1	0,01	2,74	2,33	0,40
					Total:	0,10	56,02	51,01	5,00	
Marina high table 265	Box 1	2730	140	120	1	0,05	23,40	21,40	2,00	
	Tabletop width 720 mm	Box 2	2730	140	80	1	0,03	15,50	14,30	1,20
		Box 3	870	145	75	2	0,02	13,30	11,70	1,60
		Box 4	870	145	75	1	0,01	2,39	2,05	0,34
					Total:	0,11	54,59	49,45	5,14	
Marina high table 265	Box 1	2730	140	120	2	0,09	46,80	42,80	4,00	
	Tabletop width 870 mm	Box 3	870	145	75	2	0,02	18,88	17,28	1,60
		Box 4	870	145	75	1	0,01	2,74	2,33	0,40
					Total:	0,12	68,42	62,41	6,00	
Marina high table 335	Box 1	3430	140	120	1	0,06	29,50	27,00	1,50	
	Tabletop width 720 mm	Box 2	3430	140	80	1	0,04	19,60	18,00	1,60
		Box 3	870	145	75	2	0,02	13,30	11,70	1,60
		Box 4	870	145	75	1	0,01	2,39	2,05	0,40
					Total:	0,13	64,79	58,75	5,10	
Marina high table 335	Box 1	3430	140	120	2	0,12	59,00	54,00	5,00	
	Tabletop width 870 mm	Box 3	870	145	75	2	0,02	18,88	17,28	1,60
		Box 4	870	145	75	1	0,01	2,74	2,33	0,40
					Total:	0,15	80,62	73,61	7,00	
Marina high table 405	Box 1	4130	140	120	1	0,07	35,70	32,70	3,00	
	Tabletop width 720 mm	Box 2	4130	140	80	1	0,05	23,70	21,80	1,90
		Box 3	870	145	75	2	0,02	13,30	11,70	1,60
		Box 4	870	145	75	1	0,01	2,39	2,05	0,40
					Total:	0,15	75,09	68,25	6,90	
Marina high table 405	Box 1	4130	140	120	2	0,14	71,40	65,40	6,00	
	Tabletop width 870 mm	Box 3	870	145	75	2	0,02	18,88	17,28	1,60
		Box 4	870	145	75	1	0,01	2,74	2,33	0,40
					Total:	0,17	93,02	85,01	8,00	

Box dimensions - Marina table 3 legs

The Marina table comes in 3 or 4 boxes

Box 1: 3 profiles



Box 2: 2 profiles



Box 3: Set table legs + mounting kit



Box 4: Endcaps (+ reinforcement profiles) + mounting kit



Box dimensions (mm)		L	W	H	Qty	Volume (m ³)	Gross weight (kg)	Net weight (kg)	Packaging weight (kg)	
Marina high table 475	Box 1	4830	140	120	1	0,08	41,90	38,30	3,60	
	Tabletop width 720 mm	Box 2	4830	140	80	1	0,05	27,90	25,60	2,30
		Box 3	870	145	75	3	0,03	13,30	11,70	2,40
		Box 4	870	145	75	1	0,01	2,39	2,05	0,40
					Total:	0,17	85,49	77,65	2,80	
Marina high table 475	Box 1	4830	140	120	2	0,16	83,80	76,60	7,20	
	Tabletop width 870 mm	Box 3	870	145	75	3	0,03	18,88	17,28	2,40
		Box 4	870	145	75	1	0,01	2,74	2,33	0,40
						Total:	0,20	105,42	96,21	10,00
Marina high table 545	Box 1	5530	140	120	1	0,09	48,10	44,00	4,10	
	Tabletop width 720 mm	Box 2	5530	140	80	1	0,06	32,00	29,30	2,70
		Box 3	870	145	75	3	0,03	13,30	11,70	2,40
		Box 4	870	145	75	1	0,01	2,39	2,05	0,40
					Total:	0,19	95,79	87,05	9,60	
Marina high table 545	Box 1	5530	140	120	2	0,19	96,20	88,00	8,20	
	Tabletop width 870 mm	Box 3	870	145	75	3	0,03	18,88	17,28	2,40
		Box 4	870	145	75	1	0,01	2,74	2,33	0,40
						Total:	0,23	117,82	107,61	11,00
Marina high table 615	Box 1	6230	140	120	1	0,10	54,20	49,60	4,60	
	Tabletop width 720 mm	Box 2	6230	140	80	1	0,07	36,10	33,10	3,00
		Box 3	870	145	75	3	0,03	13,30	11,70	2,40
		Box 4	870	145	75	1	0,01	2,39	2,05	0,40
					Total:	0,21	105,99	96,45	10,40	
Marina high table 615	Box 1	6230	140	120	2	0,21	108,40	99,20	9,20	
	Tabletop width 870 mm	Box 3	870	145	75	3	0,03	18,88	17,28	2,40
		Box 4	870	145	75	1	0,01	2,74	2,33	0,40
						Total:	0,25	130,02	118,81	12,00
Marina high table 685	Box 1	6930	140	120	1	0,12	60,40	55,30	5,10	
	Tabletop width 720 mm	Box 2	6930	140	80	1	0,08	40,20	36,90	3,30
		Box 3	870	145	75	3	0,03	13,30	11,70	2,40
		Box 4	870	145	75	1	0,01	2,39	2,05	0,40
					Total:	0,24	116,29	105,95	11,20	
Marina high table 685	Box 1	6930	140	120	2	0,23	120,80	110,60	10,20	
	Tabletop width 870 mm	Box 3	870	145	75	3	0,03	18,88	17,28	2,40
		Box 4	870	145	75	1	0,01	2,74	2,33	0,40
						Total:	0,27	142,42	130,21	13,00

Floor fastening

The floor fastening is available in one version

Floor fastening box

The floor fastening comes in 1 box

[Box 8: Floor fastening](#)



Box dimensions (mm)		L	W	H	Qty	Volume (m ³)	Gross weight (kg)	Net weight (kg)	Packaging weight (kg)
Floor fastening	Box 8	205	145	150	1	0,01	0,30	0,23	0,07

Marina high table + Captain's Chairs

How many people can sit on a Marina high table?

2 legs

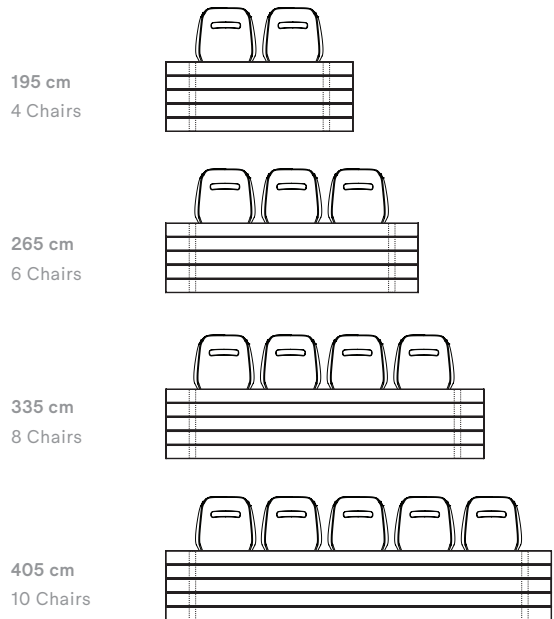



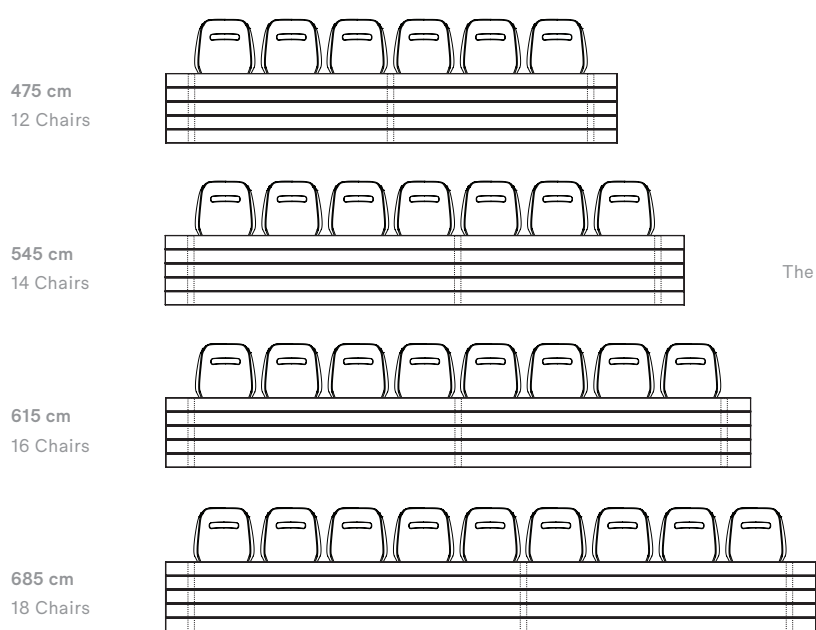

3 legs



The position of the legs is assymetrical

The position of the legs is assymetrical

Tabletop, legs & endcaps

	Off white (RAL9002) Structured powder coating
	Verdigris Structured powder coating
	Reed green (RAL6013) Structured powder coating
	Copper brown (RAL8004) Structured powder coating



Materials	Key facts	Thickness	Layer thickness	Density	In/outdoor	Water	UV color fastness	Flame retarding
		mm	micron					
Coated fiberglass tabletop	<ul style="list-style-type: none"> Made with pultrusion technique: a non-stop process of fibre glass wires pulled through a bath of polyester Strong Lightweight 	2,7	n.a.	1,80 10 ³ kg/m ³	Outdoor & indoor	n.a.	Very good: color can fade to some extent when exposed to UV	/
Structured powder coated zinc steel legs	<ul style="list-style-type: none"> Easy to clean Electro galvanized (for extra protection against rust), then powder coated More scratch-resistant than non structured powder coating 	3	100	7,50 10 ³ kg/m ³	Outdoor & indoor	n.a.	Very good: color can fade to some extent when exposed to UV	NEN-EN13501-1 A1 *
Polyamide feet	<ul style="list-style-type: none"> Injection-moulded nylon Adjustable in height and surface 	n.a.	n.a.	1,14 10 ³ kg/m ³	Outdoor & indoor	n.a.	Very good	/

NEN-EN13501-1 A1

Class A1 products will not contribute to fire in any stage, including fully developed fire. For this reason, they are assumed to be capable of satisfying all requirements of all lower classes as well.

Good to know

- 70 cm chair space / person.
- The average transport volume is 0,17m³ / person, which is really low.
- Fiberglass reinforced polyester resin material is made with the so-called pultrusion technique. Pultrusion is a non-stop process of pulling fiberglass wires through a bath of polyester resin and letting them harden in a matrix afterwards to get their final shape.
- Main advantages of this material are its strength and low weight.

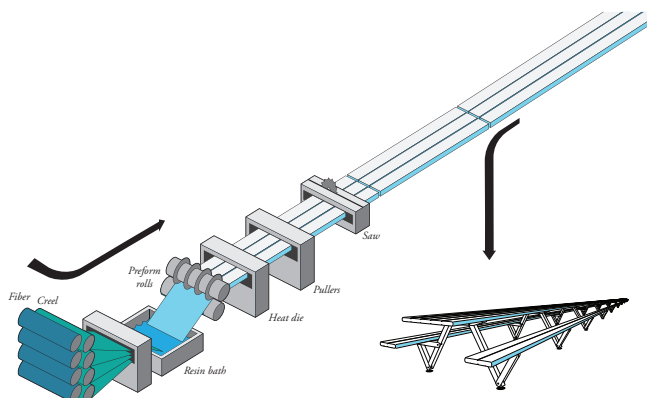

- Marina high table comes perfectly with Captain's Chairs & Tiki bar stools.



Maintenance

www.extremis.com/maintenance

POWDER COATED PARTS

- White powder coating obviously requires more maintenance.

F.A.Q.

Q: What is the biggest size possible?

A: We have produced a 30m table, the only problem is transport. We can deliver tables up to 6m without extra costs.

Q: Are the legs corrosion-resistant?

A: The legs are first galvanized, and powder-coated afterwards. This way, we have a double protection layer.

Floor fastening

Marina table comes with an optional floor fastening set. Find more instructions in the manual.



Warnings

General

- Do not use any sharp tools to open the packaging.
- We strongly advise against using power tools.
- Tripping hazard, mind your step.
- Do not put out cigarettes on the table.
- Not graffiti proof.
- Do not leave children unattended whilst playing on the table.
- To avoid danger of suffocation, keep plastic bags away from babies and children.
- Colors can differ over years and from batch to batch.

Product

- Do not drag the table, but carry it with minimum 2 people.
- Anchoring the product has to be done by qualified people.

- For anchoring: use suitable bolts or screws from a specialized store depending on the material your terrace is made of.
- We strongly advise you against standing on top of the table! A concentrated load can cause small perceptible cracks in the profiles that might be visually annoying, although they do not affect the strength of the table in any way.
- For table with 3 legs or more, we recommend using trestles to attach the table leg assemblies to the tabletop, instead of keeping it upside down.

Coated fiberglass

- Do not use abrasive scouring powders or scourers as they will scratch the surface.
- Color can fade to some extent when exposed to UV.
- Dark colors can get very hot in sunny weather.

Powder coating

- White powder coating requires more maintenance.
- Do not use abrasive scouring powders or scourers as they will scratch the surface.
- Color can fade to some extent when exposed to UV.
- Flame retarding - NEN-EN13501-1 A2-sl - Satisfying the same criteria as Class B for the SBI-test according to EN13823. In addition, under conditions of a fully developed fire these products will not significantly contribute to the fire load and fire growth.
- Dark colors can get very hot in sunny weather.

The content of this document, in particular the mentioned models, is protected by copyrights and/or design rights. The present document and its content is communicated to you for information purposes only. Any partial or total reproduction or any other use without our prior written permission is strictly prohibited. This technical sheet remains subject to possible changes. **All dimensions are in mm**, unless mentioned otherwise. Extremis is not responsible for the errors in the documentation of products. All measurements are approximate and are provided for informational purposes only.

**Tech
sheet**

20231215