

# Sticks

© Design by Hsu-Li Teo & Stefan Kaiser for Extremis, 2003



## Dimensions

The standard base with rods is available in 4 heights

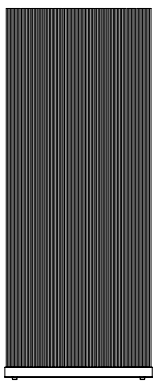
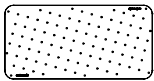

23.5



11.75

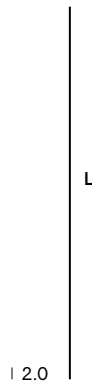

Dimensions (inch)	L
Standard base with 120 rods	48.0
Standard base with 150 rods	59.75
Standard base with 7.0 rods	71.75
Standard base with 210 rods	83.5

The standard base with Biophilic rods is available in 1 height

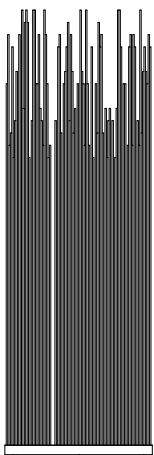
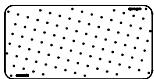

23.5



11.75

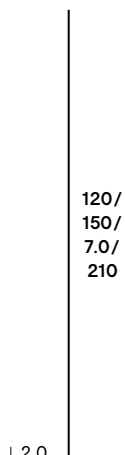

The sharp curved base with rods is available in 4 heights

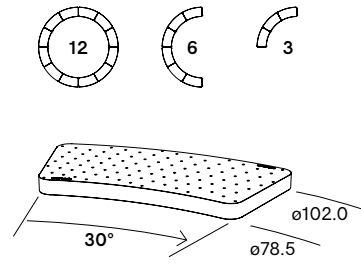
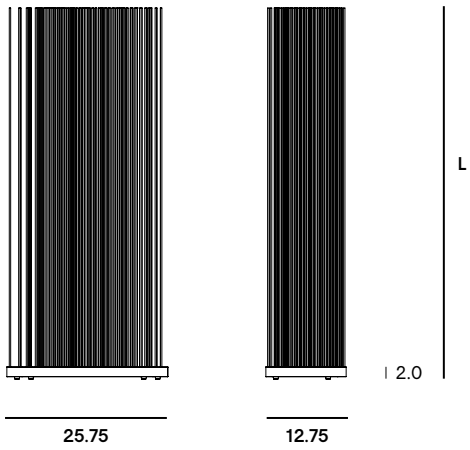
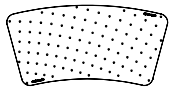

Dimensions (inch)	L
Sharp curved base with 120 rods	48.0
Sharp curved base with 150 rods	59.75
Sharp curved base with 210 rods	71.75
Sharp curved base with 280 rods	83.5

The wide curved base with rods is available in 4 heights

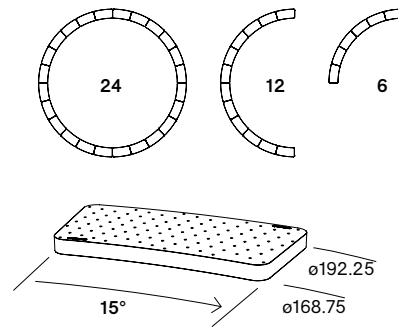
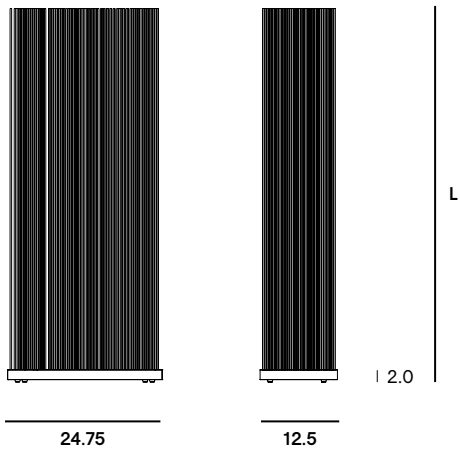
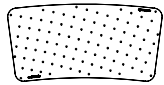

Dimensions (inch)	L
Wide curved base with 120 rods	48.0
Wide curved base with 150 rods	59.75
Wide curved base with 210 rods	71.75
Wide curved base with 280 rods	83.5

# Box dimensions

Sticks comes in 1 box and 1 bag

Bag 1: Rubber bases

Box 1: Rubber base with LED /  
Wooden bases (with LED)

Box 2: Rubber curved bases with LED /  
Wooden curved bases (with LED)



Box dimensions (inch)		L	W	H	Qty	Volume (ft <sup>3</sup> )	Gross weight (lb)	Net weight (lb)	Packaging weight (lb)
<b>Standard base rubber</b>	Bag 1	24.75	11.75	1.5	1	0.35	22.27	22.05	0.22
Rods 120 cm	Bag 2	47.25	7.0	7.0	1	1.41	14.11	13.89	0.22
Total:						<b>1.76</b>	<b>36.38</b>	<b>35.94</b>	<b>0.44</b>
<b>Standard base rubber</b>	Bag 1	24.75	11.75	1.5	1	0.35	22.27	22.05	0.22
Rods 150 cm	Bag 2	59.0	7.0	7.0	1	1.77	17.64	17.42	0.22
Total:						<b>2.12</b>	<b>39.91</b>	<b>39.47</b>	<b>0.44</b>
<b>Standard base rubber</b>	Bag 1	24.75	11.75	1.5	1	0.35	22.27	22.05	0.22
Rods 7.0 cm	Bag 2	70.75	7.0	7.0	1	2.12	20.81	20.59	0.22
Total:						<b>2.47</b>	<b>43.08</b>	<b>42.64</b>	<b>0.44</b>
<b>Standard base rubber</b>	Bag 1	24.75	11.75	1.5	1	0.35	22.27	22.05	0.22
Rods 210 cm	Bag 2	82.75	7.0	7.0	1	2.47	24.38	24.16	0.22
Total:						<b>2.82</b>	<b>46.65</b>	<b>46.21</b>	<b>0.44</b>
<b>Standard base rubberwood</b>	Box 1	24.75	11.75	2.0	1	0.35	11.24	11.02	0.22
Rods 120 cm	Bag 2	47.25	7.0	7.0	1	1.41	14.11	13.89	0.22
Total:						<b>1.76</b>	<b>25.35</b>	<b>24.91</b>	<b>0.44</b>
<b>Standard base rubberwood</b>	Box 1	24.75	11.75	2.0	1	0.35	11.24	11.02	0.22
Rods 150 cm	Bag 2	59.0	7.0	7.0	1	1.77	17.64	17.42	0.22
Total:						<b>2.12</b>	<b>28.88</b>	<b>28.44</b>	<b>0.44</b>
<b>Standard base rubberwood</b>	Box 1	24.75	11.75	2.0	1	0.35	11.24	11.02	0.22
Rods 7.0 cm	Bag 2	70.75	7.0	7.0	1	2.12	20.81	20.59	0.22
Total:						<b>2.47</b>	<b>32.05</b>	<b>31.61</b>	<b>0.44</b>
<b>Standard base rubberwood</b>	Box 1	24.75	11.75	2.0	1	0.35	11.24	11.02	0.22
Rods 210 cm	Bag 2	82.75	7.0	7.0	1	2.47	24.38	24.16	0.22
Total:						<b>2.82</b>	<b>35.62</b>	<b>35.18</b>	<b>0.44</b>

Box dimensions (inch)		L	W	H	Qty	Volume (ft <sup>3</sup> )	Gross weight (lb)	Net weight (lb)	Packaging weight (lb)	
<b>Sharp curved base rubber</b>	Bag 1	25.5	12.5	1.5	1	0.35	22.71	22.05	0.66	
Rods 120 cm	Bag 2	47.25	7.0	7.0	1	1.41	14.11	13.89	0.22	
						<b>Total:</b>	<b>1.76</b>	<b>36.82</b>	<b>35.94</b>	<b>0.88</b>
<b>Sharp curved base rubber</b>	Bag 1	25.5	12.5	1.5	1	0.35	22.71	22.05	0.66	
Rods 150 cm	Bag 2	59.0	7.0	7.0	1	1.77	17.64	17.42	0.22	
						<b>Total:</b>	<b>2.12</b>	<b>40.35</b>	<b>39.47</b>	<b>0.88</b>
<b>Sharp curved base rubber</b>	Bag 1	25.5	12.5	1.5	1	0.35	22.71	22.05	0.66	
Rods 7.0 cm	Bag 2	70.75	7.0	7.0	1	2.12	20.81	20.59	0.22	
						<b>Total:</b>	<b>2.47</b>	<b>43.52</b>	<b>42.64</b>	<b>0.88</b>
<b>Sharp curved base rubber</b>	Bag 1	25.5	12.5	1.5	1	0.35	22.71	22.05	0.66	
Rods 210 cm	Bag 2	82.75	7.0	7.0	1	2.47	24.38	24.16	0.22	
						<b>Total:</b>	<b>2.82</b>	<b>47.09</b>	<b>46.21</b>	<b>0.88</b>
<b>Sharp curved base rubberwood</b>	Bag 1	28.25	325	2.0	1	0.35	11.68	11.02	0.66	
Rods 120 cm	Bag 2	47.25	7.0	7.0	1	1.41	14.11	13.89	0.22	
						<b>Total:</b>	<b>1.76</b>	<b>25.79</b>	<b>24.91</b>	<b>0.88</b>
<b>Sharp curved base rubberwood</b>	Bag 1	28.25	325	2.0	1	0.35	11.68	11.02	0.66	
Rods 150 cm	Bag 2	59.0	7.0	7.0	1	1.77	17.64	17.42	0.22	
						<b>Total:</b>	<b>2.12</b>	<b>29.32</b>	<b>28.44</b>	<b>0.88</b>
<b>Sharp curved base rubberwood</b>	Bag 1	28.25	325	2.0	1	0.35	11.68	11.02	0.66	
Rods 7.0 cm	Bag 2	70.75	7.0	7.0	1	2.12	20.81	20.59	0.22	
						<b>Total:</b>	<b>2.47</b>	<b>32.49</b>	<b>31.61</b>	<b>0.88</b>
<b>Sharp curved base rubberwood</b>	Bag 1	28.25	325	2.0	1	0.35	11.68	11.02	0.66	
Rods 210 cm	Bag 2	82.75	7.0	7.0	1	2.47	24.38	24.16	0.22	
						<b>Total:</b>	<b>2.82</b>	<b>36.06</b>	<b>35.18</b>	<b>0.88</b>
<b>Wide curved base rubber</b>	Bag 1	25.5	12.5	1.5	1	0.35	22.71	22.05	0.66	
Rods 120 cm	Bag 2	47.25	7.0	7.0	1	1.41	14.11	13.89	0.22	
						<b>Total:</b>	<b>1.76</b>	<b>36.82</b>	<b>35.94</b>	<b>0.88</b>
<b>Wide curved base rubber</b>	Bag 1	25.5	12.5	1.5	1	0.35	22.71	22.05	0.66	
Rods 150 cm	Bag 2	59.0	7.0	7.0	1	1.77	17.64	17.42	0.22	
						<b>Total:</b>	<b>2.12</b>	<b>40.35</b>	<b>39.47</b>	<b>0.88</b>
<b>Wide curved base rubber</b>	Bag 1	25.5	12.5	1.5	1	0.35	22.71	22.05	0.66	
Rods 7.0 cm	Bag 2	70.75	7.0	7.0	1	2.12	20.81	20.59	0.22	
						<b>Total:</b>	<b>2.47</b>	<b>43.52</b>	<b>42.64</b>	<b>0.88</b>
<b>Wide curved base rubber</b>	Bag 1	25.5	12.5	1.5	1	0.35	22.71	22.05	0.66	
Rods 210 cm	Bag 2	82.75	7.0	7.0	1	2.47	24.38	24.16	0.22	
						<b>Total:</b>	<b>2.82</b>	<b>47.09</b>	<b>46.21</b>	<b>0.88</b>
<b>Wide curved base rubberwood</b>	Bag 1	25.5	13.75	2.0	1	0.35	11.68	11.02	0.66	
Rods 120 cm	Bag 2	47.25	7.0	7.0	1	1.41	14.11	13.89	0.22	
						<b>Total:</b>	<b>1.76</b>	<b>25.79</b>	<b>24.91</b>	<b>0.88</b>
<b>Sharp curved base rubberwood</b>	Bag 1	25.5	13.75	2.0	1	0.35	11.68	11.02	0.66	
Rods 150 cm	Bag 2	59.0	7.0	7.0	1	1.77	17.64	17.42	0.22	
						<b>Total:</b>	<b>2.12</b>	<b>29.32</b>	<b>28.44</b>	<b>0.88</b>
<b>Sharp curved base rubberwood</b>	Bag 1	25.5	13.75	2.0	1	0.35	11.68	11.02	0.66	
Rods 7.0 cm	Bag 2	70.75	7.0	7.0	1	2.12	20.81	20.59	0.22	
						<b>Total:</b>	<b>2.47</b>	<b>32.49</b>	<b>31.61</b>	<b>0.88</b>
<b>Sharp curved base rubberwood</b>	Bag 1	25.5	13.75	2.0	1	0.35	11.68	11.02	0.66	
Rods 210 cm	Bag 2	82.75	7.0	7.0	1	2.47	24.38	24.16	0.22	
						<b>Total:</b>	<b>2.82</b>	<b>36.06</b>	<b>35.18</b>	<b>0.88</b>

# Extra weight dimensions

The extra weight for the standard bases is available in one version

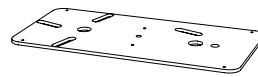
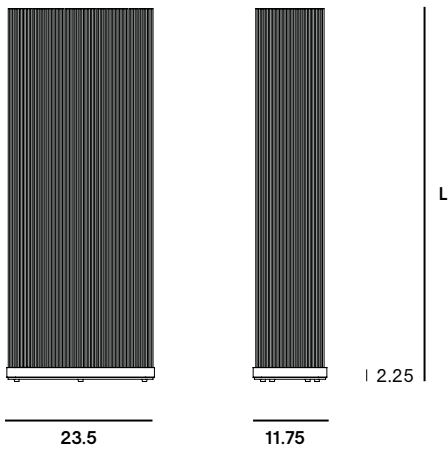

Dimensions (inch)	L
Standard base & extra weight with 120 rods	48.25
Standard base & extra weight with 150 rods	60.25
Standard base & extra weight with 7.0 rods	72.0
Standard base & extra weight with 210 rods	83.75

The extra weight for the sharp curved bases is available in one version

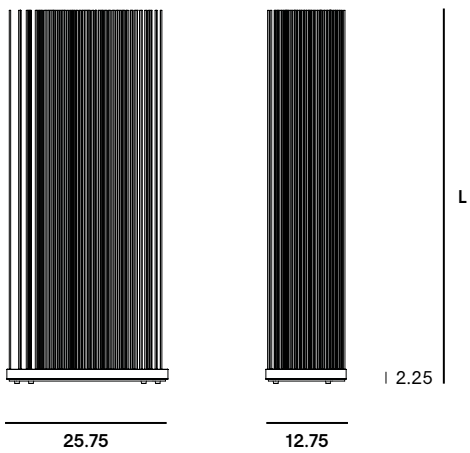

Dimensions (inch)	L
Sharp curved base & extra weight with 120 rods	48.25
Sharp curved base & extra weight with 150 rods	60.25
Sharp curved base & extra weight with 7.0 rods	72.0
Sharp curved base & extra weight with 210 rods	83.75

The extra weight for the wide curved bases is available in one version

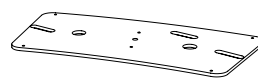
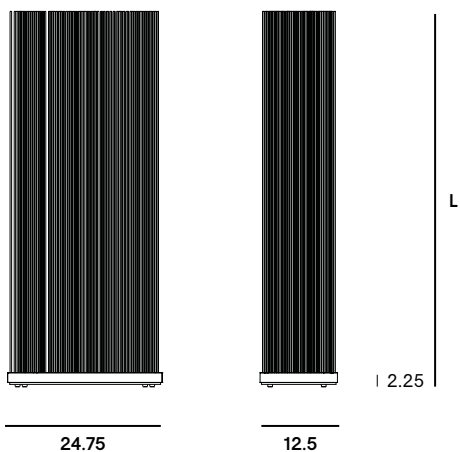

Dimensions (inch)	L
Wide curved base & extra weight with 120 rods	48.25
Wide curved base & extra weight with 150 rods	60.25
Wide curved base & extra weight with 7.0 rods	72.0
Wide curved base & extra weight with 210 rods	83.75

# Extra weight box dimensions

---

The extra weight comes in 1 box

[Box 3](#): Extra weight ( standard bases)



[Box 4](#): Extra weight (sharp curved bases)



[Box 5](#): Extra weight (wide curved bases)



Box dimensions (inch)		L	W	H	Qty	Volume (ft <sup>3</sup> )	Gross weight (lb)	Net weight (lb)	Packaging weight (lb)
Extra weight for standard bases	Box 3	24.75	12.25	2.0	1	0.35	22.71	22.49	0.22
Extra weight for sharp curved bases	Box 4	28.25	12.75	2.0	1	0.35	22.71	22.49	0.22
Extra weight for wide curved bases	Box 5	28.25	12.75	2.0	1	0.35	22.71	22.49	0.22

# Materials & colors

Check price list or [www.extremis.com](http://www.extremis.com) for current materials & colors

## Bases



Rubber



Rubberwood  
Natural



Rubberwood  
Dark

## Extra weight



Galvanized steel

## LEDs



Cool white  
25.50K



Warm white  
11.750K

## Rods



White



Black



Wood color



Green



Materials	Key facts	Thickness inch	Layer thickness micron	Density	In/outdoor	Water	UV color fastness	Flame retarding
Fiberglass rods	<ul style="list-style-type: none"> <li>Made with pultrusion technique: a non-stop process of fibre glass wires pulled through a bath of polyester resin</li> <li>Strong</li> <li>Flexible</li> <li>Lightweight</li> </ul>	0.25	n.a.	0,03 10 <sup>9</sup> lb/ft <sup>3</sup>	Outdoor & indoor	n.a.	Very good: color can fade to some extent when exposed to UV	/
Rubber base	<ul style="list-style-type: none"> <li>Made from mostly regenerated rubber, more ecological</li> <li>Rubber can cause black marks on the floor by direct contact</li> <li>Use protection feet</li> </ul>	0.06	n.a.	0,08 10 <sup>9</sup> lb/ft <sup>3</sup>	Outdoor & indoor	n.a.	Good	/
Rubberwood base	<ul style="list-style-type: none"> <li>Wood of the rubber tree, very valuable</li> <li>High stability</li> <li>Easy to process</li> <li>Ecologically sustainable wood</li> <li>Treated with oil to make it more resistant to dirt and to maintain its colour</li> </ul>	0.06	50 - 100	0.10 oz/ft <sup>2</sup>	Indoor	n.a.	n.a.	/
LEDs	<ul style="list-style-type: none"> <li>Color temperature of 25.50K (cool white) or 11.750K (warm white)</li> <li>Beam angle of 25°</li> <li>13.75mA</li> <li>2 x 3,2W</li> <li>100 - 220 V; 50 - 60 Hz</li> <li>Up to 20 LEDs per plug, i.e. 10 straight or curved bases</li> </ul>	n.a.	n.a.	n.a.	Outdoor & indoor	IP65	/	/
Lead, plug & stop	<ul style="list-style-type: none"> <li>Supplied plug is of the type F</li> <li>In countries where this plug is not used, a plug will have to be fitted locally by an electrician</li> <li>Up to 18 LEDs per plug, i.e. 9 straight or curved bases in a row</li> </ul>	n.a.	n.a.	n.a.	Outdoor & indoor	IP65	/	/
Hot dip galvanized steel extra weight	<ul style="list-style-type: none"> <li>Most durable method for protecting metal from rusting</li> <li>Protective layer</li> <li>Very long life span</li> <li>100% recyclable</li> <li>Cradle to Cradle Certified™</li> </ul>	0.31	n.a.	0,47 10 <sup>9</sup> lb/ft <sup>3</sup>	Outdoor & indoor	n.a.	Very good, galvanization will however become less shiny when used outdoors	NEN-EN113.751-1 A1 *

NEN-EN113.751-1 A1

Class A1 products will not contribute to fire in any stage, including fully developed fire. For this reason, they are assumed to be capable of satisfying all requirements of all lower classes as well.







# Warranty

Our quality promise, made solid. Material based warranty.

Each material has unique properties, and the warranty covers issues specific to each. Steel should not rust, coatings should not peel, and wood should not rot. We have outlined the warranty coverage for all materials in our Warranty Chart for your convenience.

Based on our 30 years of expertise with wood, fabrics and metals, we now offer 5 to 15 years warranty.

	<p><b>GALVANIZED STEEL</b>          Enjoy an impressive 15-year warranty on all galvanized steel parts. We proudly use this exceptional Cradle to Cradle certified technique to protect steel from rusting, incorporating it into nearly all our designs.</p>
	<p><b>COATED METALS, STAINLESS STEEL, WOOD AND SUNBRELLA</b>          We offer a comprehensive 5-year warranty on all powder coated metal parts, stainless steel components, wooden parts, and Sunbrella fabrics. This extension ensures that all key materials of our products are covered</p>

						
	Galvanized steel	Stainless steel	Coated metals	Wood species	Sunbrella fabrics	Other materials
Structural — Functional	<b>15 years</b>	<b>5 years</b>	<b>5 years</b>	<b>5 years</b>	<b>5 years</b>	<b>2 years</b>
Rust	<b>15 years</b>	<b>5 years</b>	<b>5 years</b>			
Wood rot				<b>5 years</b>		
Cracks				<b>5 years</b> for cracks > 4 mm		
Terms apply: Please read our commercial warranty statement <a href="#">here</a>						



## Good to know

- In 2003, Extremis launched the most internationally oriented product of a Chinese-German couple living in Australia, put on the market by a Belgian company, and (partially) manufactured in Sri Lanka. The Sri Lanka production unit is part of a development project set up by the 'Building a Future Foundation'. BAF Foundation is a special purpose foundation that is established with the sole and only purpose to create a future for the youth along the coastal areas affected by tsunami by bringing in new activities, technologies, skills and trainings in order to generate such economic activities and employment opportunities
- You do not have to insert all the rods. To achieve more transparency, you can always put fewer sticks in bases.
- Biophilic rods: the rods vary in height between 120/150/180/210 cm.
- Combine the Biophilic rods with any base.



## Maintenance

[www.extremis.com/maintenance](http://www.extremis.com/maintenance)

### RUBBER & FIBERGLASS RODS

- The rubber and the fiberglass rods do not require special maintenance. They can simply be kept dustfree with a slightly damp cloth.

### GALVANIZED PARTS

- Clean with lukewarm water and a mild detergent or Extremis multi cleaner.

## Floor fastening

Sticks base can be anchored to the ground by drilling a hole in the ground and putting a screw (ø 0.25 inch) through the middle of the base (instead of a rod) in the ground.

## F.A.Q.

*Q: How many rods are there in one base?*

A: 1 bunch of rods = 49 rods  
Standard & curved bases → 2 bunches of 49 rods = 98 rods

*Q: Are the rods safe for children? Can it cause skin irritations by touching the rods?*

A: The rods are covered with a protective layer, so the fiberglass won't hurt the skin. Because of the production process, some fiberglass dust may stick to the rods, so we advise to wear gloves for the assembly.

*Q: How many bases with LEDs can be fixed to each other with only 1 power supply?*

A: Up to 9 bases with 1 power supply.  
Up to 8 bases with 1 power supply & a connection cable of 39.25 inch.  
Up to 6 bases with 1 power supply & a connection cable of 157.5 inch.  
Up to 4 bases with 1 power supply & a connection cable of 354.25 inch.

## Warnings

### General

- Do not use any sharp tools to open the packaging.
- We strongly advise against using power tools.
- Tripping hazard, mind your step.
- Do not put out cigarettes on the product.
- Not graffiti proof.
- Do not leave children unattended whilst playing on the table.
- To avoid danger of suffocation, keep plastic bags away from babies and children.
- Colors can differ over years and from batch to batch.

### Product

- Anchoring the product has to be done by qualified people.
- For anchoring: use suitable bolts or screws from a specialized store depending on the material your terrace is made of.
- We consequently recommend that you thoroughly dust or rinse the rods before inserting them into the bases to reduce these fibres to a minimum.
- Do not touch the fiberglass rods with your bare hands. Always use gloves to assemble Sticks. During the production process tiny glass fibers may come loose and could stick on the rods. In case of skin contact they may cause slight irritation. We consequently recommend that you thoroughly dust or rinse the rods before inserting them into the bases to reduce these fibers to a minimum.

- Do not allow anyone to use the rods for playing or jousting. This may cause injuries.
- Because of the specific characteristics of the production process of fiberglass, colors can only be reproduced approximately and color differences may occur. This is the case for both standard colors as for colours upon request.
- Rubberwood bases are not suitable for outdoor use.
- When using the Sticks high up or in windy places, we advise you to attach the bases to the ground. In places where this is not possible, we offer a weighted base.
- Make sure the electrical modules (bases with LED lighting, cables, adapters and switches) never end up in a puddle.

### Fiberglass

- Stains should be removed immediately with a clean, soft cloth, particularly in case of dark-coloured liquids such as wine, ink, coffee, coke, oil or bird droppings. If left to dry, these liquids may cause permanent damage!
- Avoid using aggressive and abrasive products.
- The white hue can change to some extent when exposed to UV.
- With darker colors, the ends may look lighter because of the white glass fibers.
- Color variations are possible, and even likely. This is intrinsic to this production technique. It contributes to the natural effect.

### Rubber

- Rubber can cause stains on delicate floor, therefore, we advise to use the plastic feet.
- Rubber can cause stains on carpets, therefore, we advise to use only the wooden bases on carpets
- Rubber has a distinctive smell but it will fade over time.

### Galvanized steel

- Galvanization will become less shiny when used outdoors.
- Flame retarding - NEN-EN113.751-1 A1 - Class A1 products will not contribute to fire in any stage, including fully developed fire. For this reason, they are assumed to be capable of satisfying all requirements of all lower classes as well.
- Possible impurities in the immersion tank can cause black marks during galvanization, which are intrinsic to this industrial finishing technique.
- White marks on this zinc layer are also intrinsic to this procedure and will disappear when the furniture is put outdoors.
- This industrial finishing technique may result in a rougher surface. This is intrinsic to the process.

The content of this document, in particular the mentioned models, is protected by copyrights and/or design rights. The present document and its content is communicated to you for information purposes only. Any partial or total reproduction or any other use without our prior written permission is strictly prohibited. This technical sheet remains subject to possible changes. All dimensions are in inch, unless mentioned otherwise. Extremis is not responsible for the errors in the documentation of products. All measurements are approximate and are provided for informational purposes only.

**Tech  
sheet**  
20250523