

# Gargantua

© Design by Dirk Wynants for Extremis, 1994

extremis®

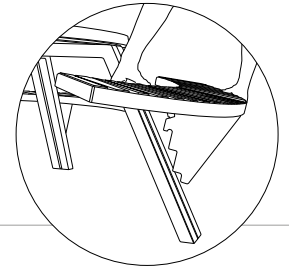

## Dimensions

The Gargantua is available in one dimension

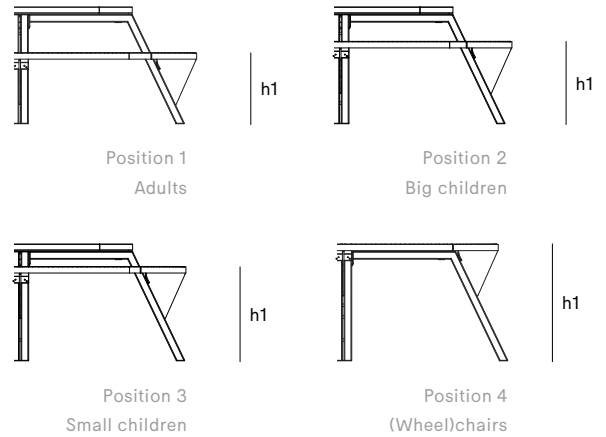
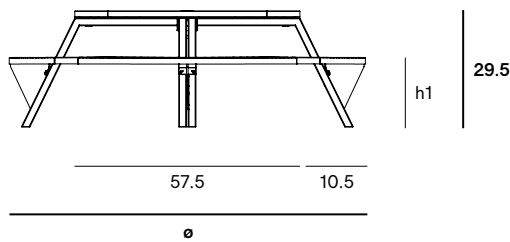
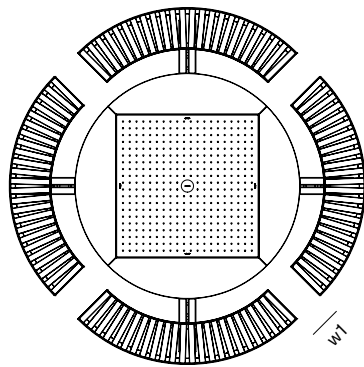

Dimensions (inch)	ø	h1	w1
Position 1	91.0	17.75	8.25
Position 2	88.0	20.5	6.25
Position 3	85.0	23.5	4.25
Position 4	79.25	29.5	0

## Box dimensions

The Gargantua comes in 5 boxes

Box 1: Tabletop

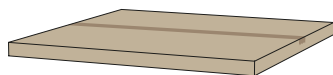

Box 2: benches



Box 3: Legs

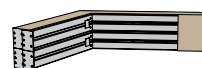

Box 4: Bench supports + mounting kit



Box dimensions (inch)		L	W	H	Qty	Volume (ft <sup>3</sup> )	Gross weight (lb)	Net weight (lb)	Packaging weight (lb)
Gargantua	Box 1	60.25	59.0	3.25	1	6.36	111.11	97.44	13.67
	Box 2	57.0	20.75	4.0	2	5.30	119.93	112.88	7.05
	Box 3	72.75	9.5	4.25	1	0.71	87.30	81.13	6.17
	Box 4	13.0	10.75	10.0	1	1.77	46.30	40.57	5.73
Total:						<b>14.14</b>	<b>364.64</b>	<b>332.02</b>	<b>32.62</b>

## Backrest

The backrest is available in one dimension

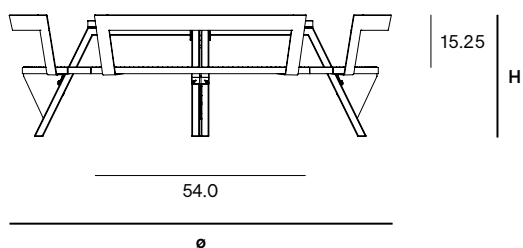
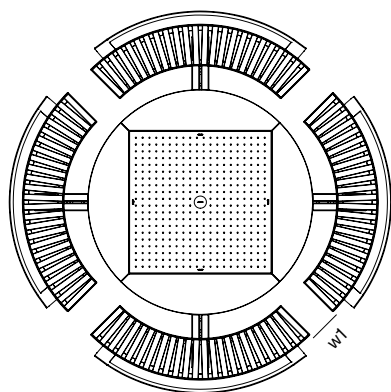

## Backrest box

The backrests comes in 1 box

Box 5: Backrest (2x)

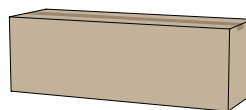

Dimensions (inch)	ø	H
Position 1	97.25	31.0
Position 2	94.75	34.0
Position 3	91.75	37.0

Box dimensions (inch)		L	W	H	Qty	Volume (ft <sup>3</sup> )	Gross weight (lb)	Net weight (lb)	Packaging weight (lb)
Backrest (2pcs per box)	Box 5	56.0	18.5	18.5	1	10.95	52.91	44.09	8.82

## Cushions

The cushions is available in one dimension

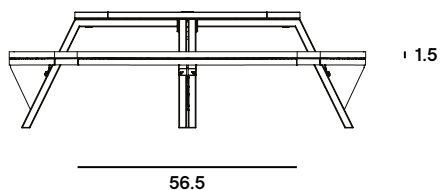
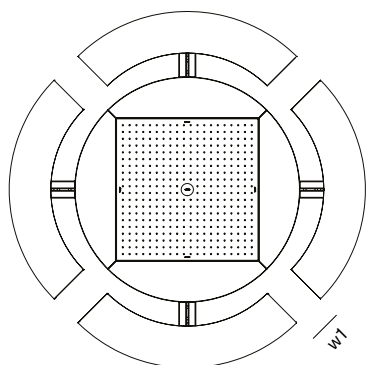

## Cushions box

The cushions comes in 1 box

Box 6: Cushions (4x)



Box dimensions (inch)		L	W	H	Qty	Volume (ft <sup>3</sup> )	Gross weight (lb)	Net weight (lb)	Packaging weight (lb)
Cushions (4pcs per box)	Box 6	56.25	19.0	9.0	1	5.65	15.87	10.58	5.29

## Floor fastening

The floor fastening is available in one dimension

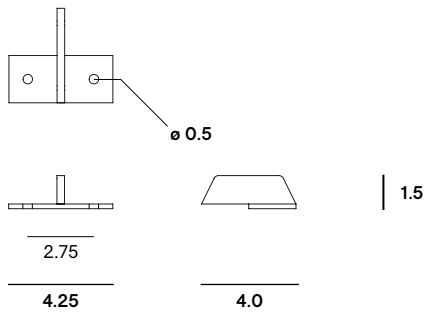

## Floor fastening box

The floor fastening comes in 1 box

Box 7: Floor fastening



Box dimensions (inch)		L	W	H	Qty	Volume (ft <sup>3</sup> )	Gross weight (lb)	Net weight (lb)	Packaging weight (lb)
Floor fastening	Box 7	8.0	5.75	6.0	1	0.35	3.53	3.37	0.15

These dimensions can be used for pre-drilling the holes into the ground to later attach the ground anchor

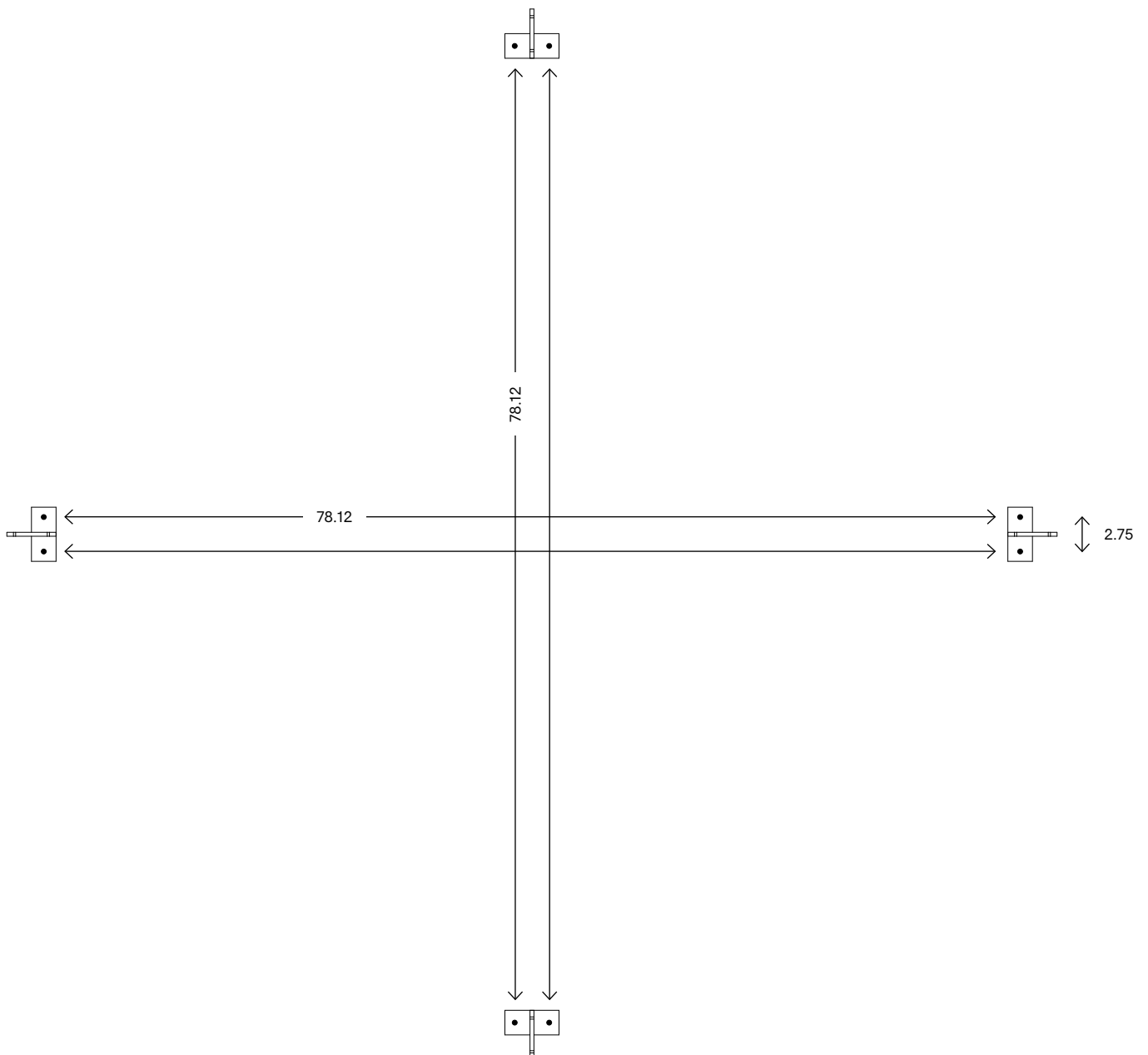

## Bench fastening

The bench fastening is available in one dimension

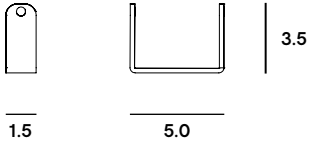

## Bench fastening box

The bench fastening comes in 1 box

[Box 8: Bench fastening](#)



Box dimensions (inch)		L	W	H	Qty	Volume (ft <sup>3</sup> )	Gross weight (lb)	Net weight (lb)	Packaging weight (lb)
Bench fastening	Box 8	8.0	5.75	6.0	1	0.35	3.53	3.37	0.15

# Wheelchair accessibility dimensions

As specifications for wheelchair accessibility vary around the world, please review the dimensions below to ensure the measurements of each solution meet the specifications of your local requirements

Put two benches at tabletop height (there are no obstacles underneath the tabletop)

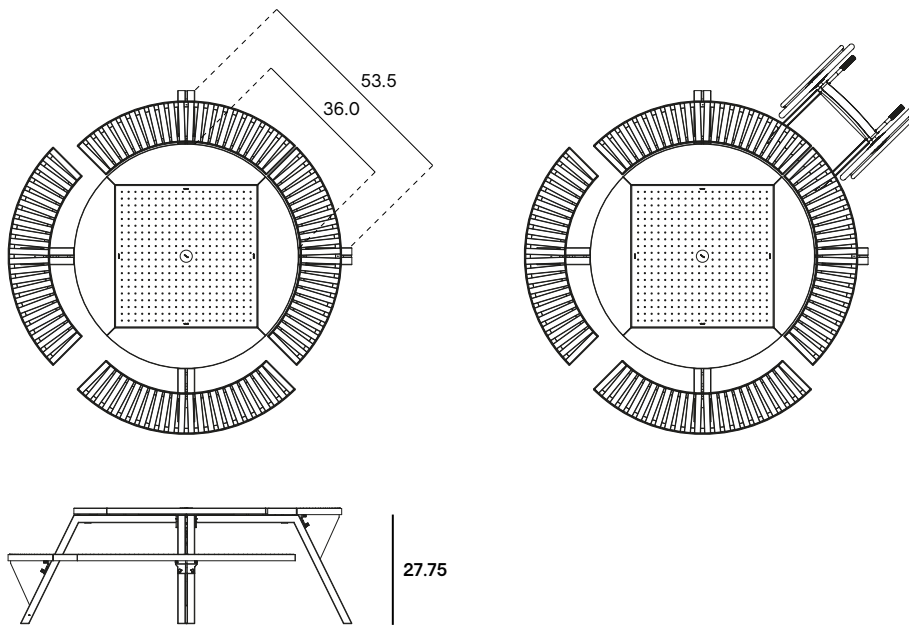

# Materials & colors

Check price list or [www.extremis.com](http://www.extremis.com) for current materials & colors

## Tabletop & benches

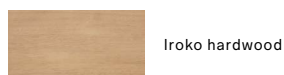

## Sunbrella® cushions

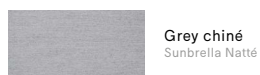

## Frame, legs & backrest

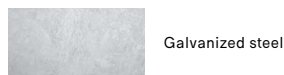

## Tabletop centerplate

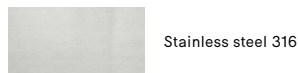

Materials	Key facts	Thickness	Layer thickness	Density	In/outdoor	Water	UV color fastness	Flame retarding
		inch	micron					
Iroko tabletop & benches	<ul style="list-style-type: none"> <li>Durability CLASS 1</li> <li>Feels comfortable in all weather conditions</li> <li>Advisable to oil the wood</li> </ul>	0.79 benches 1.57 tabletop	n.a.	37 à 43 lb/ft <sup>3</sup>	Outdoor & indoor	n.a.	Untreated wood turns grey after a while	/
Hot dip galvanized steel frame, legs & backrest	<ul style="list-style-type: none"> <li>Most durable method for protecting metal from rusting</li> <li>Protective layer</li> <li>Very long life span</li> <li>100% recyclable</li> <li>Cradle to Cradle Certified™</li> </ul>	0.07 - 0.39	50 - 100	0.47 10 <sup>3</sup> lb/ft <sup>3</sup>	Outdoor & indoor	n.a.	Very good, galvanization will however become less shiny when used outdoors	NEN-EN13501-1 A1 *
Stainless steel tabletop centerplate AISI 316	<ul style="list-style-type: none"> <li>High rust resistance</li> <li>Periodical maintenance required</li> </ul>	0.07	n.a.	0.50 10 <sup>3</sup> lb/ft <sup>3</sup>	Outdoor & indoor	n.a.	Very good	NEN-EN13501-1 A1 *
Sunbrella® cushions	<ul style="list-style-type: none"> <li>100% Sunbrella Acrylic</li> <li>Best outdoor fabric available for making cushions</li> <li>Dirt repellent</li> <li>Not waterproof, store inside!</li> <li>Machine washable at max. 30°C. Ironing restores the protective layer</li> </ul>	0,02	n.a.	9.17 oz/ft <sup>2</sup>	Outdoor & indoor	The fabric has a water column of 350 mm (EN 20811)	7/8 (ISO 105-B02)	/



NEN-EN13501-1 A1 Class A1 products will not contribute to fire in any stage, including fully developed fire. For this reason, they are assumed to be capable of satisfying all requirements of all lower classes as well.

# Warranty

Our quality promise, made solid. Material based warranty.

Each material has unique properties, and the warranty covers issues specific to each. Steel should not rust, coatings should not peel, and wood should not rot. We have outlined the warranty coverage for all materials in our Warranty Chart for your convenience.

Based on our 30 years of expertise with wood, fabrics and metals, we now offer 5 to 15 years warranty.

<p><b>15 — YEAR</b></p> 	<p><b>GALVANIZED STEEL</b>          Enjoy an impressive 15-year warranty on all galvanized steel parts. We proudly use this exceptional Cradle to Cradle certified technique to protect steel from rusting, incorporating it into nearly all our designs.</p>
<p><b>5 — YEAR</b></p> 	<p><b>COATED METALS, STAINLESS STEEL, WOOD AND SUNBRELLA</b>          We offer a comprehensive 5-year warranty on all powder coated metal parts, stainless steel components, wooden parts, and Sunbrella fabrics. This extension ensures that all key materials of our products are covered</p>

						
	Galvanized steel	Stainless steel	Coated metals	Wood species	Sunbrella fabrics	Other materials
Structural — Functional	<b>15 years</b>	<b>5 years</b>	<b>5 years</b>	<b>5 years</b>	<b>5 years</b>	<b>2 years</b>
Rust	<b>15 years</b>	<b>5 years</b>	<b>5 years</b>			
Wood rot				<b>5 years</b>		
Cracks				<b>5 years</b> for cracks > 4 mm		
Terms apply: Please read our commercial warranty statement <a href="#">here</a>						

## Good to know

- The hole in the tabletop to place a parasol in is ø2.5 inch.
- Gargantua combines perfectly with Inumbra medium/large & Inumbra large. For both combinations, a connection piece is required.



## F.A.Q.

Q: Do you need to oil the wood?

A: Just like other types of wood, wood will gradually become rougher and start to turn grey as a consequence of exposure to the sun and rain. Small cracks and crevices can also appear as part of this process. We strongly advise everyone to treat the furniture with our Wood Protector. This 100% natural oil controls the moisture level within the wood, which makes the planks stay stable for longer, and the layer of oil also helps to prevent spilled liquids from being absorbed, so that stains tend to stay superficial. It is best to repeat this treatment at regular intervals.

Q: All benches on the highest level = a table for 12 people?

A: Yes, but this position is not meant to be used all the time.

## Floor fastening

Gargantua has an optional floor fastening set, four galvanized steel plates to be fixed with bolts.



## Maintenance

[www.extremis.com/maintenance](http://www.extremis.com/maintenance)

### GALVANIZED PARTS

- Clean with lukewarm water and a mild detergent or Extremis multi cleaner.

### WOOD

- Clean regularly with mild detergent.
- Thorough cleaning with Extremis Wood Cleaner.
- Oil the wood with Extremis Wood Protector. We recommend oiling the wood at regular intervals depending from location and general weather conditions.
- In order to smoothen the surface again after a thorough cleaning, lightly sand your wood with 120 grit sanding paper or a sanding pad.

### STAINLESS STEEL



- Clean regularly with a dry cloth and some stainless steel cleaner

### SUNBRELLA

- Shake or brush off loose dirt immediately.
- Spray Extremis Multi Cleaner.
- Use a soft brush and make circular movements.
- Let the suds soak in for a moment.
- Rinse thoroughly to remove all soap residue.
- Simply allow to dry.
- It's also possible to put the blanket and the pillow covers in a washing machine (max 40°C). Follow the cleaning instruction on the label.
- If the cushion has metal brackets, we recommend turning the cover inside out first to avoid damaging the washing machine. In this case, leave the zipper open about 10 cm.

### RECOMMENDED USE

- For Extremis Wood protector:

		
7 to 10 wood care treatments	3 to 5 wood care treatments	100 - 150 ml for one Gargantua

## Bench fastening

For public spaces, Gargantua comes with an optional bench fastening set: four galvanised steel brackets to be fixed to the legs.

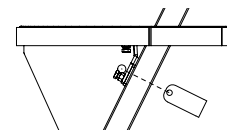

## Warnings

### General

- Do not use any sharp tools to open the packaging.
- We strongly advise against using power tools.
- Tripping hazard, mind your step.
- Do not put out cigarettes on the table.
- Not graffiti proof.
- Do not leave children unattended whilst playing on the table.
- To avoid danger of suffocation, keep plastic bags away from babies and children.
- Colors can differ over years and from batch to batch.

### Product

- Do not stand or jump on the table.
- Do not drag the table, but carry it with minimum 2 people.
- Anchoring the product has to be done by qualified people.
- For anchoring: use suitable bolts or screws from a specialized store depending on the material your terrace is made of.
- To change the height of the bench, grab the bench with both hands on the frame and do not pull on the wood.
- Make sure the bench is securely fixed and is hanging in a horizontal position.
- The slight movement you feel when sitting down is the result of the space we need to hook or unhook the benches. If this would be too narrow, moving the benches would no longer be possible.
- Gargantua is not designed to keep the benches at the highest level at all time. We recommend to

only place the benches at the tabletop level for exceptional situations. The benches and tabletop do not form an even surface; level deviations up to 1 cm may appear.

- The centreplate of the tabletop reflects in the sunlight.
- Max. 3 people or 529 lb per bench.

### Wood

- When delivered, the wood is untreated.
- Wood is a natural material and its look is different for every slat, plank and tree.
- Wood will gradually become rougher and start to turn grey as a consequence of exposure to the sun and rain. We recommend oiling the wood at regular intervals depending from location and general weather conditions.
- Clean regularly with mild detergent. Never use a high pressure cleaner as this will roughen the wood's smooth surface and irreparably damage the wood's fiber.
- Thorough cleaning with Extremis Wood Cleaner.
- We strongly recommend that you treat your wood with wood protector to protect it from stains - small cracks and crevices can also appear as part of this process. We strongly advise everyone to treat the furniture with our Wood Protector.

### Galvanized steel

- Galvanization will become less shiny when used outdoors.
- Flame retarding - NEN-EN13501-1 A1 - Class A1

products will not contribute to fire in any stage, including fully developed fire. For this reason, they are assumed to be capable of satisfying all requirements of all lower classes as well.

- Possible impurities in the immersion tank can cause black marks during galvanization, which are intrinsic to this industrial finishing technique.
- White marks on this zinc layer are also intrinsic to this procedure and will disappear when the furniture is put outdoors.
- This industrial finishing technique may result in a rougher surface. This is intrinsic to the process.

### Stainless steel

- Very good UV color fastness.
- Flame retarding: NEN-EN13501-1 A1 - Class A1 products will not contribute to fire in any stage, including fully developed fire. For this reason, they are assumed to be capable of satisfying all requirements of all lower classes as well.
- Watch out, stainless steel isn't entirely rustproof! Be sure to avoid contact with iron objects. If it does show signs of rust, clean with rust remover as quickly as possible.

### Sunbrella

- Not waterproof, store inside!
- Shake or brush off loose dirt immediately.
- UV color fastness: 7/8 (ISO 105-B02).

The content of this document, in particular the mentioned models, is protected by copyrights and/or design rights. The present document and its content is communicated to you for information purposes only. Any partial or total reproduction or any other use without our prior written permission is strictly prohibited. This technical sheet remains subject to possible changes. All dimensions are in inch, unless mentioned otherwise. Extremis is not responsible for the errors in the documentation of products. All measurements are approximate and are provided for informational purposes only.

**Tech sheet**  
20250605