

KOSMOS

© *design by dirk wynants*

READ INSIDE

ASSEMBLY INSTRUCTIONS,
HOW TO USE, USEFUL TIPS
FOR KEEPING YOUR TOOL FOR
TOGETHERNESS IN SHAPE

LANGUAGES

EN – NL – DE – FR – IT – ES

MORE

WWW.EXTREMIS.BE

PRODUCT

KOSMOS 3 ZIT – FREESTANDING TABLE – MAINTENANCE

LANGUAGES

ENGLISH P. 3

contents	p. 3
assembly kosmos 3-seater	p. 4
assembly freestanding table	p. 4
assembly cover	p. 5
maintenance	p. 6

NEDERLANDS P. 9

inhoud	p. 9
montage kosmos 3-zit	p. 10
montage vrijstaande tafel	p. 10
montage hoes	p. 11
onderhoud	p. 12

DEUTSCH P. 15

inhalt	p. 15
montage kosmos 3-sitzer	p. 16
montage Separater Tisch	p. 16
montage Schutzhülle	p. 17
pflege	p. 18

FRANÇAIS P. 21

contenu	p. 21
montage kosmos 3-places	p. 22
montage table autonome	p. 22
montage housse	p. 23
entretien	p. 24

ITALIANO P. 27

contenuto	p. 27
montaggio kosmos 3 posti	p. 28
montaggio tavolo indipendente	p. 28
montaggio fodera	p. 29
manutenzione	p. 30

ESPAÑOL P. 33

contenido	p. 33
monaje kosmos tresillo	p. 34
montaje mesa autónoma	p. 34
montaje funda	p. 35
mantenimiento	p. 36

CONTENTS

3-SEATER

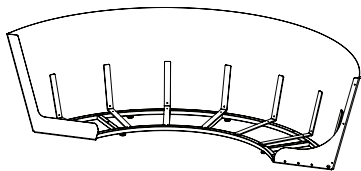

1 x half
(low or high)

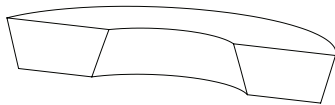

1 x large seat cushion



1 x small seat cushion
(low or high)



2 x large back cushion
(low or high)

OPTIONAL

FREESTANDING TABLE

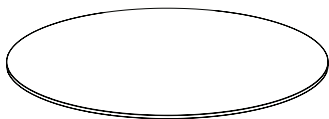

1 x tabletop

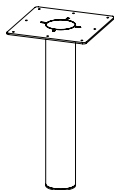

1 x tube



1 x base plate

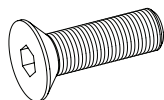

3 x M6x25 countersunk bolt

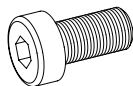

8 x M6x12 bolt

ASSEMBLY KOSMOS 3-SEATER

WHAT YOU NEED



2 people



+/- 5 min.

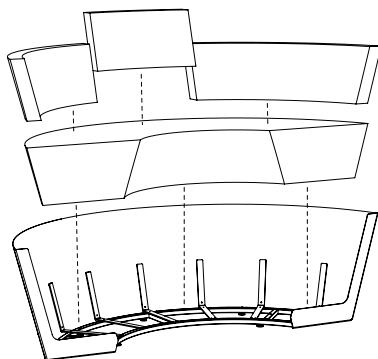

1. Put the seat frame in its desired position. **Loosen the adjustable feet, which are not touching the ground, from above using a flat blade screwdriver. Make sure that the element is perfectly level.** Arrange the cushions as shown in the diagram.

ASSEMBLY FREESTANDING TABLE

WHAT YOU NEED



1 person



no. 4 hex key



+/- 15 min.

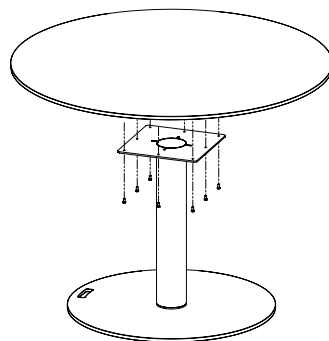
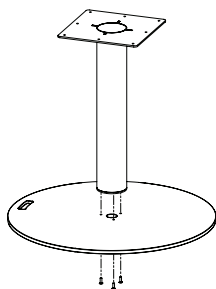

1. Take the base plate and attach this to the bottom of the tube using 3 M6x25 countersunk bolts as shown on the figure.

2. Position the tabletop on the tube as shown in the figure above using 8 M6x12 hexagon socket bolts.

COVER



1. Slide the cover over the Kosmos 3-seater.
BE CAREFUL: make sure the cover is positioned correctly, as in the photo above.



2. Pull the zip downwards to close it.



3. Done.

MAINTENANCE

CUSHIONS

They are easy to clean with warm water and a microfibre cleaning cloth. Never use solvents, bleaching agents, abrasives, chemical detergents nor waxes. If the Kosmos is used outdoors, always cover it completely with the optional cover when you are not using it, as the cushions are not 100% waterproof for ventilation purposes.

The cushions should be cleaned periodically in order to maintain their appearance and to prevent the build up of dirt and bacteria.

Lacquers and inks, strong cleaners, detergents and solvents such as thinner, acetone or alcohol can be very effective in removing stains, but cause immediate damage and contribute to the deterioration of the material. The use of such cleaners is at the owner's risk.

TABLE

HPL (high-pressure laminate) is easy to clean with standard cleaning products such as those used for cleaning kitchens. In case of tenacious stains we use "HG plastic, paint and wall paper intensive cleaner". For more information on this product, please visit the website www.hginternational.com.

WARNING

Do never sit on the backrest aluminium plate, to avoid damage to cushions or aluminium.



WWW.EXTREMIS.BE

LANGUAGES

ENGLISH P. 3

contents	p. 3
assembly kosmos 3-seater	p. 4
assembly freestanding table	p. 4
assembly cover	p. 5
maintenance	p. 6

NEDERLANDS P. 9

inhoud	p. 9
montage kosmos 3-zit	p. 10
montage vrijstaande tafel	p. 10
montage hoes	p. 11
onderhoud	p. 12

DEUTSCH P. 15

inhalt	p. 15
montage kosmos 3-sitzer	p. 16
montage Separater Tisch	p. 16
montage Schutzhülle	p. 17
pflege	p. 18

FRANÇAIS P. 21

contenu	p. 21
montage kosmos 3-places	p. 22
montage table autonome	p. 22
montage housse	p. 23
entretien	p. 24

ITALIANO P. 27

contenuto	p. 27
montaggio kosmos 3 posti	p. 28
montaggio tavolo indipendente	p. 28
montaggio fodera	p. 29
manutenzione	p. 30

ESPAÑOL P. 33

contenido	p. 33
monaje kosmos tresillo	p. 34
montaje mesa autónoma	p. 34
montaje funda	p. 35
mantenimiento	p. 36

INHOUD

3-ZIT

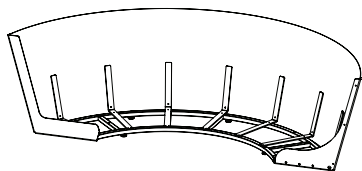

1 x zetelhelft
(laag of hoog)

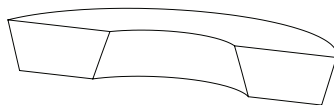

1 x groot zitkussen



1 x klein rugkussen
(laag of hoog)



2 x groot rugkussen
(laag of hoog)

OPTIONEEL

VRIJSTAANDE TAFEL

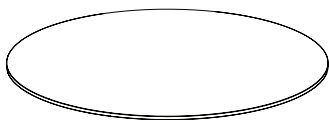

1 x tafelblad

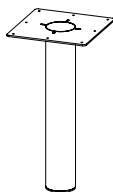

1 x buis



1 x voetplaat

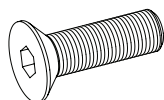

3 x verzonken binnzeskantbout M6x25

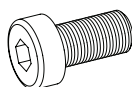

8 x binnzeskantbout M6x12

MONTAGE KOSMOS 3-ZIT

BENODIGDHEDEN



2 personen



+/- 5 min.

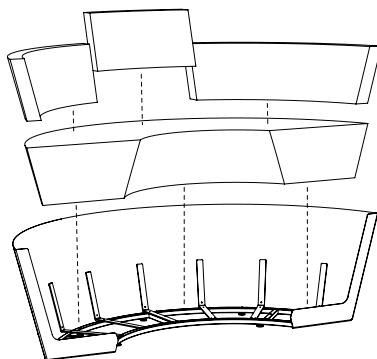

1. Plaats het zetelframe op de gewenste plaats. **Draai nu de stelvoetjes die het grondoppervlak niet raken van bovenaf met een platte schroevendraaier uit en zorg verder dat het geheel waterpas komt te staan.** Leg nu de kussens erin.

MONTAGE VRIJSTAANDE TAFEL

BENODIGDHEDEN



1 persoon



inbussleutel nr. 4



+/- 15 min.

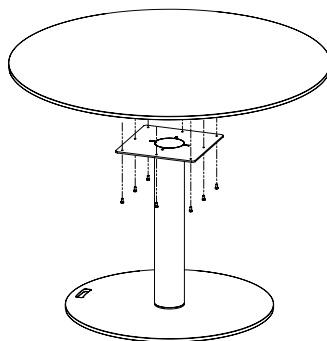
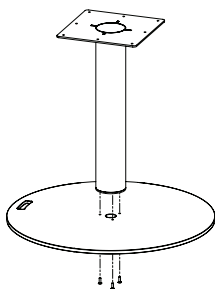

1. Neem de voetplaat en monteer deze d.m.v. 3 verzonken binnenzeskantbouten M6x25 aan de onderkant van de inoxen buis zoals aangegeven op bovenstaande tekening.
2. Plaats nu het tafelblad op de inoxen buis zoals aangegeven op de tekening en bevestig deze d.m.v. 8 binnenzeskantbouten M6x12.

HOES



1. Schuif de hoes over de Kosmos 3-zit.

LET OP: zorg ervoor dat de hoes juist gepositioneerd zit, zoals op bovenstaande afbeelding.



2. Doe de rits naar beneden.



3. Klaar.

ONDERHOUD

KUSSENS

Eenvoudig te reinigen met warm water en een microvezeldoek. Gebruik geen solventen, bleekmiddelen, schuurmiddelen, chemische detergents of waxen. **Bij buitentoepassing dient telkens de optionele hoes over het hele meubel geplaatst worden** wanneer dit niet in gebruik is, gezien de kussens om ventilatie redenen niet 100% waterdicht zijn.

De kussens moeten regelmatig gereinigd worden om zo hun uiterlijk te behouden en om de vorming van vuil en bacteriën tegen te gaan.

Lakken en inkten, schoonmaakmiddelen, wasmiddelen en oplosmiddelen zoals thinner, aceton of alcohol kunnen zeer effectief zijn in het verwijderen van vlekken, maar veroorzaken directe schade en dragen bij aan de verslechtering van het materiaal. Het gebruik van dergelijke reinigingsmiddelen is op eigen risico.

TAFEL

HPL (high pressure laminate): te reinigen met standaard reinigingsmiddelen zoals men gebruikt voor de keuken. Voor hardnekkige verontreinigingen gebruiken wij zelf "HG kunststof, verf en behang intensief reiniger". Voor meer info: www.hginternational.com

WAARSCHUWING

Ga nooit zitten op de rugleuning om beschadiging aan de kussens en de aluminiumplaat te vermijden.



WWW.EXTREMIS.BE

LANGUAGES

ENGLISH P. 3

contents	p. 3
assembly kosmos 3-seater	p. 4
assembly freestanding table	p. 4
assembly cover	p. 5
maintenance	p. 6

NEDERLANDS P. 9

inhoud	p. 9
montage kosmos 3-zit	p. 10
montage vrijstaande tafel	p. 10
montage hoes	p. 11
onderhoud	p. 12

DEUTSCH P. 15

inhalt	p. 15
montage kosmos 3-sitzer	p. 16
montage Separater Tisch	p. 16
montage Schutzhülle	p. 17
pflege	p. 18

FRANÇAIS P. 21

contenu	p. 21
montage kosmos 3-places	p. 22
montage table autonome	p. 22
montage housse	p. 23
entretien	p. 24

ITALIANO P. 27

contenuto	p. 27
montaggio kosmos 3 posti	p. 28
montaggio tavolo indipendente	p. 28
montaggio fodera	p. 29
manutenzione	p. 30

ESPAÑOL P. 33

contenido	p. 33
monaje kosmos tresillo	p. 34
montaje mesa autónoma	p. 34
montaje funda	p. 35
mantenimiento	p. 36

INHALT

3-SITZER

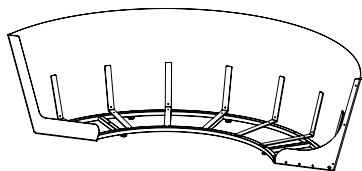

1 x Sofahälfte
(niedrig oder hoch)

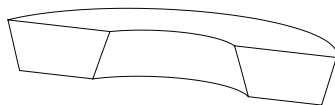

1 x großes Sitzkissen



1 x kleine Rückenlehne
(niedrig oder hoch)



2 x große Rückenlehne
(niedrig oder hoch)

OPTIONAL

SEPARATER TISCH

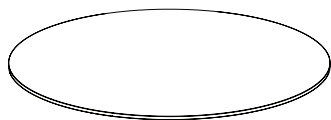

1 x Tischplatte

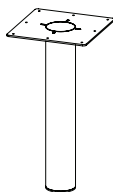

1 x Rohr



1 x Bodenplatte

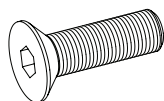

3 x Senkschraube mit Innensechskant
M6x25

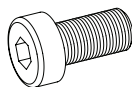

8 x Innensechskantschraube
M6x12

MONTAGE KOSMOS 3-SITZER

WAS SIE BRAUCHEN



2 Personen



+/- 5 min.

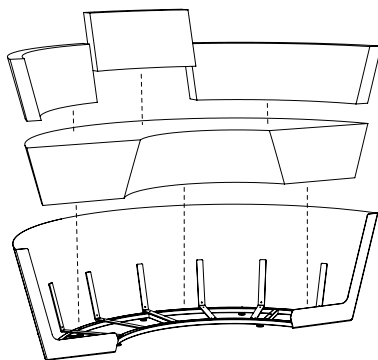

1. Stellen Sie das Sofagestell am gewünschten Standort auf. **Drehen Sie jetzt die Standfüße, die den Boden nicht berühren, von oben mit einem Schlitzschraubendreher heraus und sorgen Sie außerdem dafür, dass das Sofa waagrecht steht.** Legen Sie jetzt die Kissen hinein.

MONTAGE SEPARATER TISCH

WAS SIE BRAUCHEN



1 Person



Inbusschlüssel Nr. 4



+/- 15 min.

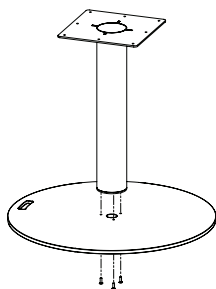

1. Nehmen Sie die Bodenplatte und montieren Sie sie mithilfe von 3 Senkschrauben mit Innensechskant M6x25 wie in obiger Skizze gezeigt an die Unterseite des Edelstahlrohrs.

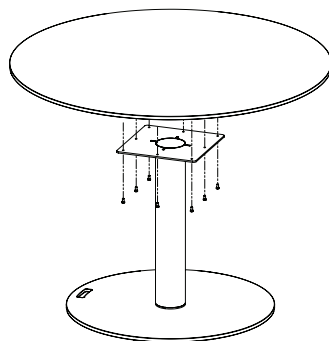

2. Legen Sie jetzt die Tischplatte wie in der Zeichnung angegeben auf das Edelstahlrohr und befestigen Sie sie mithilfe von 8 Innensechskantschrauben M6x12.

SCHUTZHÜLLE



1. Ziehen Sie die Schutzhülle über den Kosmos-3-Sitzer.
ACHTUNG: Sorgen Sie dafür, dass die Schutzhülle wie in obiger Abbildung richtig positioniert ist.



2. Ziehen Sie den Reißverschluss nach unten.



3. Fertig.

PFLEGE

KISSEN

Einfach mit warmem Wasser und einem Mikrofasertuch zu reinigen. Verwenden Sie keine Lösungs-, Bleich- und Scheuermittel, chemischen Reinigungsmittel oder Wachse. **Bei Anwendungen im Freien muss immer die optionale Schutzhülle über das gesamte Möbel gezogen werden**, wenn es nicht in Gebrauch ist, da die Kissen aus Gründen der Belüftung nicht zu 100 % wasserdicht sind.

Die Kissen müssen regelmäßig gereinigt werden, damit sie ihr äußeres Erscheinungsbild behalten und die Bildung von Schmutz und Bakterien verhindert wird.

Lacke und Tinten, Reinigungsmittel, Waschmittel und Lösungsmittel wie Verdünner, Aceton oder Alkohol können sehr effektiv bei der Entfernung von Flecken sein, aber sie verursachen direkte Schäden und tragen zu einer Verschlechterung des Materials bei. Die Verwendung solcher Reinigungsmittel erfolgt auf eigenes Risiko.

TISCH

HPL (High Pressure Laminate): Mit Standardreinigungsmitteln reinigen, wie sie auch in der Küche verwendet werden. Für hartnäckige Verschmutzungen verwenden wir selbst „HG Kunststoff-, Anstrich- und Tapeten-Intensiv-Reiniger“. Nähere Auskünfte: www.hginternational.com

WARNUNG

Setzen Sie sich niemals auf die Rückenlehne, um Beschädigungen an den Lehnenkissen und der Aluminiumplatte zu verhindern.



WWW.EXTREMIS.BE

LANGUAGES

ENGLISH P. 3

contents	p. 3
assembly kosmos 3-seater	p. 4
assembly freestanding table	p. 4
assembly cover	p. 5
maintenance	p. 6

NEDERLANDS P. 9

inhoud	p. 9
montage kosmos 3-zit	p. 10
montage vrijstaande tafel	p. 10
montage hoes	p. 11
onderhoud	p. 12

DEUTSCH P. 15

inhalt	p. 15
montage kosmos 3-sitzer	p. 16
montage Separater Tisch	p. 16
montage Schutzhülle	p. 17
pflege	p. 18

FRANÇAIS P. 21

contenu	p. 21
montage kosmos 3-places	p. 22
montage table autonome	p. 22
montage housse	p. 23
entretien	p. 24

ITALIANO P. 27

contenuto	p. 27
montaggio kosmos 3 posti	p. 28
montaggio tavolo indipendente	p. 28
montaggio fodera	p. 29
manutenzione	p. 30

ESPAÑOL P. 33

contenido	p. 33
monaje kosmos tresillo	p. 34
montaje mesa autónoma	p. 34
montaje funda	p. 35
mantenimiento	p. 36

CONTENU

3-PLACES

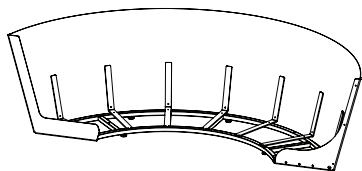

1 x demi-siège
(haut ou bas)

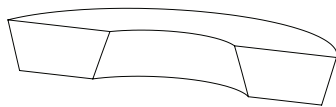

1 x grand coussin d'assise



1 x petit coussin dorsal
(haut ou bas)



2 x grand coussin dorsal
(haut ou bas)

OPTION

TABLE AUTONOME



1 x plateau de table

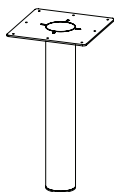

1 x tube



1 x plaque de pied

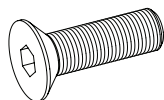

3 x vis à tête fraisée M6x25

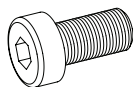

8 x vis à six pans creux M6x12

MONTAGE KOSMOS 3-PLACES

OUTILS



2 personnes



+/- 5 min.

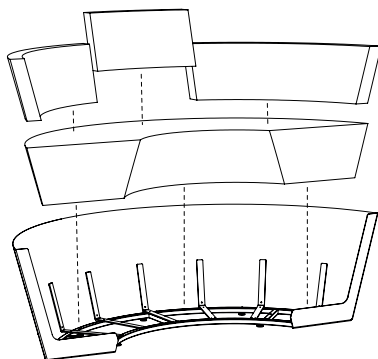

1. Positionnez le cadre du siège à l'endroit souhaité. **Par en haut, réglez ensuite les pieds qui ne touchent pas le sol au moyen d'un tournevis plat, jusqu'à ce que l'ensemble soit parfaitement à niveau.** Mettez à présent les coussins en place.

MONTAGE TABLE AUTONOME

OUTILS



1 personne



clé Allen n° 4



+/- 15 min.

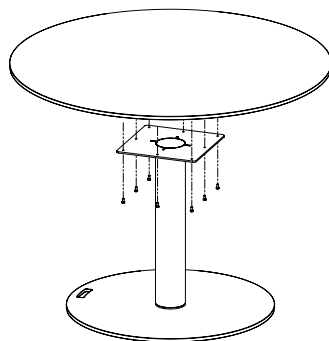
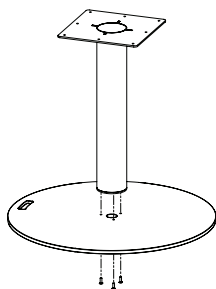

1. Prenez la plaque de pied et fixez-la au moyen des 3 vis à tête fraisée à six pans creux M6x25 à l'extrémité inférieure du tube en inox, comme illustré sur le dessin ci-dessus.

2. Placez à présent le plateau de table sur le tube en inox, comme illustré sur le dessin, et fixez-la au moyen des 8 vis à six pans creux M6x12.

HOUSSE



1. Glissez la housse par-dessus le Kosmos 3-places.
ATTENTION : veillez à ce que la housse soit bien positionnée, comme sur le dessin ci-dessus.



2. Glissez la fermeture-éclair jusqu'en bas.



3. Prêt !

ENTRETIEN

COUSSINS

Faciles à nettoyer avec de l'eau chaude et un chiffon en microfibrés. N'utilisez pas de solvants, agents de blanchiment, produits abrasifs, détergents chimiques ou cires. **En cas d'installation à l'extérieur, il convient de toujours recouvrir le meuble entièrement avec la housse en option** lorsqu'il n'est pas utilisé, étant donné que les coussins ne sont pas imperméables à 100% pour des raisons de ventilation.

Les coussins doivent être nettoyés régulièrement afin de conserver leur bel aspect et prévenir l'accumulation de saletés et de bactéries.

Les laques et encres, produits de nettoyage, lessives et solvants tels que les diluants, l'acétone ou l'alcool peuvent être très efficaces pour l'enlèvement de taches, mais peuvent aussi occasionner des dommages directs et fragiliser le matériau. L'utilisation de produits nettoyants de ce type se fera aux risques de l'utilisateur.

TABLE

HPL (high pressure laminate) : nettoyer avec des produits standard tels que ceux que l'on utilise en cuisine. Pour les saletés tenaces, nous utilisons le produit "HG détergent intensif pour matières synthétiques, peintures et papiers peint". Plus d'infos sur www.hginternational.com

ATTENTION

Ne vous asseyez jamais sur le dossier, afin d'éviter d'endommager les coussins et la structure en aluminium.



WWW.EXTREMIS.BE

LANGUAGES

ENGLISH P. 3

contents	p. 3
assembly kosmos 3-seater	p. 4
assembly freestanding table	p. 4
assembly cover	p. 5
maintenance	p. 6

NEDERLANDS P. 9

inhoud	p. 9
montage kosmos 3-zit	p. 10
montage vrijstaande tafel	p. 10
montage hoes	p. 11
onderhoud	p. 12

DEUTSCH P. 15

inhalt	p. 15
montage kosmos 3-sitzer	p. 16
montage Separater Tisch	p. 16
montage Schutzhülle	p. 17
pflege	p. 18

FRANÇAIS P. 21

contenu	p. 21
montage kosmos 3-places	p. 22
montage table autonome	p. 22
montage housse	p. 23
entretien	p. 24

ITALIANO P. 27

contenuto	p. 27
montaggio kosmos 3 posti	p. 28
montaggio tavolo indipendente	p. 28
montaggio fodera	p. 29
manutenzione	p. 30

ESPAÑOL P. 33

contenido	p. 33
monaje kosmos tresillo	p. 34
montaje mesa autónoma	p. 34
montaje funda	p. 35
mantenimiento	p. 36

CONTENUTO

3 POSTI

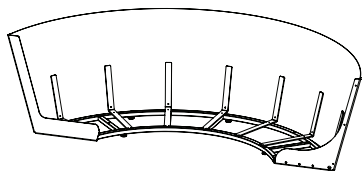

1 x metà seduta
(bassa o alta)

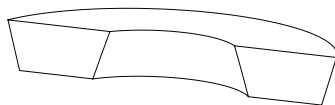

1 x cuscino seduta grande



1 x cuscino schienale piccolo
(basso o alto)



2 x cuscino schienale grande
(basso o alto)

OPZIONE

TAVOLO INDIPENDENTE

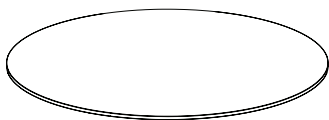

1 x piano del tavolo

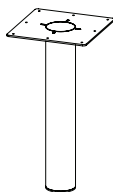

1 x gamba



1 x base

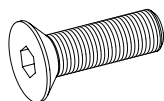

3 x vite a brugola a testa svasata
M6x25

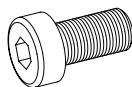

8 x vite a brugola
M6x12

MONTAGGIO KOSMOS 3 POSTI

NECESSARIO PER IL MONTAGGIO



2 persone



+/- 5 min.

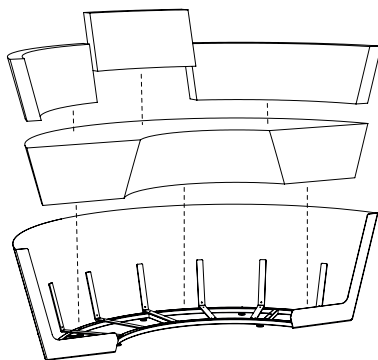

1. Posizionare la struttura della seduta nel luogo desiderato. **Con un cacciavite a taglio, avvitare dall'alto i piedini regolabili che non toccano la superficie assicurandosi che l'intera struttura si assesti in posizione orizzontale.** Inserire i cuscini.

MONTAGGIO TAVOLO INDIPENDENTE

NECESSARIO PER IL MONTAGGIO



1 persona



chiave a brugola n. 4



+/- 15 min.

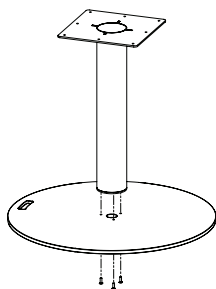

1. Prendere la base e fissarla all'estremità inferiore della gamba in acciaio inox servendosi di 3 viti a brugola a testa svasata M6x25, come mostrato in figura.

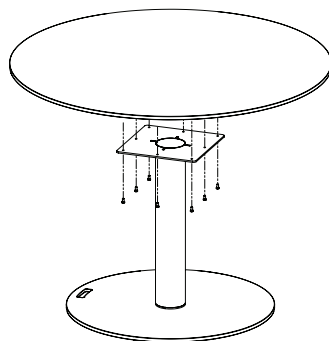

2. Ora posizionare il piano del tavolo sulla gamba in acciaio inox come mostrato in figura e fissarlo servendosi di 8 viti a brugola M6x12.

FODERA



1. Stendere la fodera sulla metà seduta di Kosmos (3 posti). **ATTENZIONE:** assicurarsi che la fodera sia posizionata correttamente, come mostrato nella foto.



2. Chiudere la cerniera.



3. Pronto.

MANUTENZIONE

CUSCINI

Facile da pulire con acqua calda e un panno in microfibra. Non utilizzare solventi, agenti sbiancanti, prodotti abrasivi, detergenti chimici o cere. Se utilizzato all'esterno, la fodera opzionale va stesa sull'intero mobile ogni volta che non viene utilizzato, poiché i cuscini per motivi di ventilazione non sono impermeabili al 100%.

I cuscini devono essere puliti regolarmente per preservarne l'aspetto esteriore e contrastare la formazione di sporco e batteri.

Le vernici e gli inchiostri, i detergenti, i detersivi e i solventi come il diluente, l'acetone o l'alcol possono essere molto efficaci nell'eliminare le macchie, ma causano danni diretti e contribuiscono al deterioramento il materiale. L'impiego di simili prodotti è a rischio dell'utilizzatore.

TAVOLO

HPL (laminato ad alta pressione): pulire con normali detergenti come quelli utilizzati in cucina. Per lo sporco ostinato noi stessi utilizziamo "HG, detergente ad azione intensa per superfici in plastica". Maggiori informazioni su www.hginternational.com

AVVERTIMENTO

Non sedersi mai sullo schienale per evitare di danneggiare i cuscini e la struttura in alluminio.



WWW.EXTREMIS.BE

LANGUAGES

ENGLISH P. 3

contents	p. 3
assembly kosmos 3-seater	p. 4
assembly freestanding table	p. 4
assembly cover	p. 5
maintenance	p. 6

NEDERLANDS P. 9

inhoud	p. 9
montage kosmos 3-zit	p. 10
montage vrijstaande tafel	p. 10
montage hoes	p. 11
onderhoud	p. 12

DEUTSCH P. 15

inhalt	p. 15
montage kosmos 3-sitzer	p. 16
montage Separater Tisch	p. 16
montage Schutzhülle	p. 17
pflege	p. 18

FRANÇAIS P. 21

contenu	p. 21
montage kosmos 3-places	p. 22
montage table autonome	p. 22
montage housse	p. 23
entretien	p. 24

ITALIANO P. 27

contenuto	p. 27
montaggio kosmos 3 posti	p. 28
montaggio tavolo indipendente	p. 28
montaggio fodera	p. 29
manutenzione	p. 30

ESPAÑOL P. 33

contenido	p. 33
monaje kosmos tresillo	p. 34
montaje mesa autónoma	p. 34
montaje funda	p. 35
mantenimiento	p. 36

CONTENIDO

TRESILLO

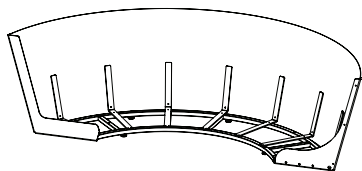

1 x pieza de sillón
(baja o alta)

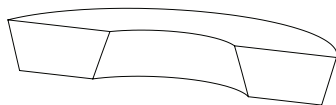

1 x colchoneta grande de asiento



1 x colchoneta pequeña de respaldo
(baja o alta)



2 x colchoneta grande de respaldo
(baja o alta)

OPCIONAL

MESA AUTÓNOMA

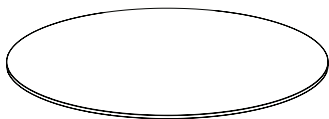

1 x tablero

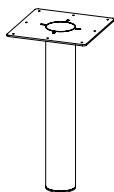

1 x tubo



1 x plataforma

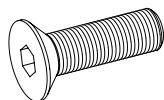

3 x tornillo avellanado M6x25

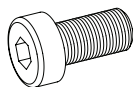

8 x tornillo M6x12

MONTAJE KOSMOS TRESILLO

UTENSILIOS



2 personas



+/- 5 min.

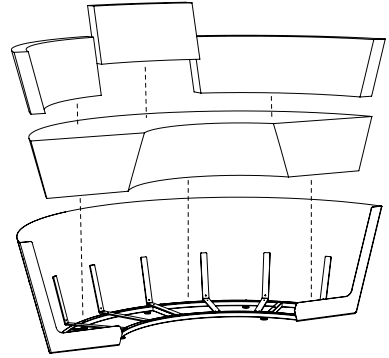

1. Ponga el armazón del sillón en el sitio deseado. **Dele una vuelta a los pies ajustables que no llegan al suelo usando un destornillador llano. Procure que el conjunto esté totalmente nivelado.** Ponga las colchonetas tal como se muestra en la figura.

MONTAJE MESA AUTÓNOMA

UTENSILIOS



1 persona



llave macho hexagonal no. 4



+/- 15 min.

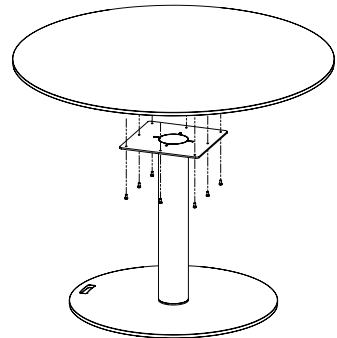
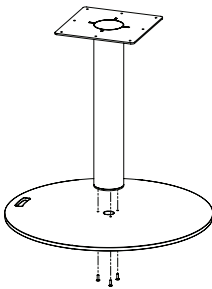

1. Coja la plataforma y móntela por debajo en el tubo de acero inoxidable usando los 3 tornillos avellanados M6x25 tal como se muestra en la figura.

2. Posicione el tablero en el tubo tal como se muestra en la figura y fíjelo usando los 8 tornillos M6x12.

FUNDA



1. Deslice la funda por encima del tresillo Kosmos.
ATENCIÓN: procure que la funda esté bien posicionada, tal como se muestra en la figura arriba.



2. Cierre la cremallera.



3. Listo.

MANTENIMIENTO

COLCHONETAS

Fáciles de limpiar con agua caliente y un paño de microfibra.

No utilice productos disolventes, decolorantes, abrasivos, detergentes químicos o cerosos. Para el empleo en el exterior, es necesario meter cada vez la funda opcional sobre todo el mueble cuando no se utiliza, ya que las colchonetas no son 100% impermeables por razones de ventilación.

Es necesario limpiar regularmente las colchonetas a fin de guardar su aspecto y evitar la formación de suciedad y bacterias.

Barnices y tintas, productos de limpieza y productos solventes, como disolvente, acetona o alcohol pueden ser muy eficaces para eliminar manchas, pero causan daños directos y contribuyen al deterioro del material. El uso de estos productos de limpieza será bajo su propio riesgo.

MESA

HPL (high pressure laminate): a limpiar con los productos normales de limpieza tales como se utilizan para la cocina. Para las suciedades recalcitrantes, nosotros solemos utilizar “HG limpiador intensivo para material sintético, pintura y papel pintado”. Para más información: www.hginternational.com

ADVERTENCIA

No se sienta nunca en el respaldo afin de evitar que las colchonetas y la placa de aluminio se deterioren.



WWW.EXTREMIS.BE

{extremis
tools for togetherness

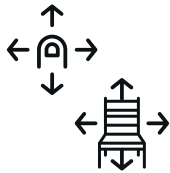

3D PLANNER & CONFIGURATOR

Check out the Extremis app:
Take a picture of your garden
and drag&drop tools for
togetherness in it!

WWW.EXTREMIS.BE

extremis®

Extremis NV

Couthoflaan 20b

B - 8972 Poperinge

t +32 57 346020

info@extremis.be

www.extremis.be



for more products go to
WWW.EXTREMIS.BE

All images, ideas, designs and design content are the intellectual property of Extremis and may not be copied, imitated or used, in whole or in part, without the prior written permission of Extremis.