

# EXTEMPORE

© design by arnold merckx

---

## **READ INSIDE**

ASSEMBLY INSTRUCTIONS,  
HOW TO USE, USEFUL TIPS  
FOR KEEPING YOUR TOOL FOR  
TOGETHERNESS IN SHAPE

## **LANGUAGES**

EN – NL – DE – FR – IT – ES

## **MORE**

[WWW.EXTREMIS.BE](http://WWW.EXTREMIS.BE)

## **PRODUCT**

EXTEMPORE TABLE EXTRA HIGH – BENCH EXTRA HIGH –  
MAINTENANCE

## LANGUAGES

### ENGLISH P. 3

contents .....	p. 3
assembly extempore bench extra high .....	p. 4
assembly extempore table extra high .....	p. 5
assembly optional floor fastening .....	p. 6
maintenance .....	p. 8

### NEDERLANDS P. 11

inhoud .....	p. 11
montage extempore bank extra hoog .....	p. 12
montage extempore tafel extra hoog .....	p. 13
montage optionele grondverankering .....	p. 14
onderhoud .....	p. 16

### DEUTSCH P. 19

inhalt .....	p. 19
montage extempore bank extra hoch .....	p. 20
montage extempore tisch extra hoch .....	p. 21
montage optional bodenverankerung .....	p. 22
pflege .....	p. 24

### FRANÇAIS P. 27

contenu .....	p. 27
montage extempore banc haut .....	p. 28
montage extempore table extra haute .....	p. 29
montage ancrage au sol en option .....	p. 30
entretien .....	p. 32

### ITALIANO P. 35

contenuto .....	p. 35
montaggio extempore panca alta .....	p. 36
montaggio extempore tavolo extra alto .....	p. 37
montaggio ancoraggio al suolo opzionale .....	p. 38
manutenzione .....	p. 40

### ESPAÑOL P. 43

contenido .....	p. 43
montage extempore banco alto .....	p. 44
montage extempore mesa extra alta .....	p. 45
montage anclaje al suelo opcional .....	p. 46
mantenimiento .....	p. 48

## CONTENTS

### BENCH EXTRA HIGH

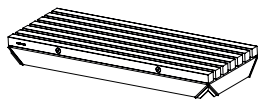

1 x bench



4 x legs



4 x assembly rods

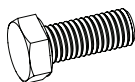

4 x bolts M8x25



1 x stainless steel rod

---

### TABLE EXTRA HIGH

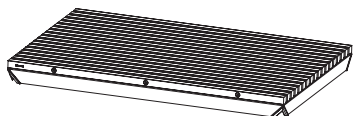

1 x tabletop



4 x legs



4 x assembly rods

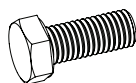

4 x bolts M8x25

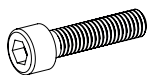

2 x bolts M6x30



1 x alu rod



2 x stainless steel rod

---

## OPTIONAL

### FLOOR FASTENING



4 x stainless steel axle

## ASSEMBLY EXTEMPORE BENCH EXTRA HIGH

### WHAT YOU NEED



2 people



no. 13 spanner



no. 4 hex key



+/- 15 min.



1. Put the bench on the ground upside down (the wooden surface should face the ground). Use the packing material to protect the surface.

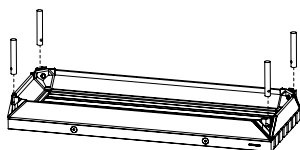

2. Insert the 4 assembly rods in the holes provided to that end in the corner elements. Tighten the rods by means of the 4 bolts using a no. 13 key. Do not tighten the bolts too much as this could cause them to break.

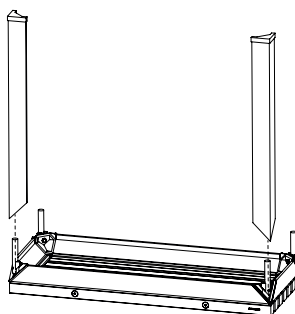

3. Place a leg, without a hole in it, over the stainless steel rod. Tighten the screws M8x25 and repeat this action for the other corner on the same long side.

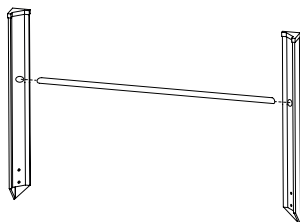

4. Put the inox tube in the holes of the 2 remaining legs.

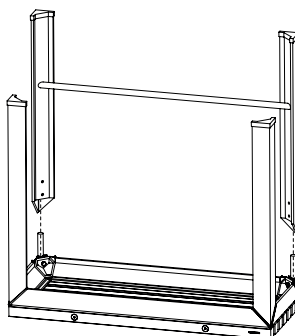

5. Place the legs over the inox rods and fix them by tightening the screws. The bench is now ready. Turn it upside down.

# MONTAGE EXTEMPORE TAFEL EXTRA HOOG

## WHAT YOU NEED



2 people



no. 13 spanner



no. 4 hex key



+/- 15 min.

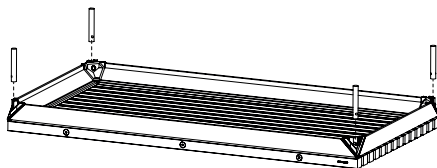

1. Put the tabletop on the ground upside down (the wooden surface should face the ground). Use the packing material to protect the surface. Insert the 4 assembly rods in the holes provided to that end in the corner elements. Tighten the rods by means of the 4 bolts using a no. 13 key. Do not tighten the bolts too much as this could cause them to break.

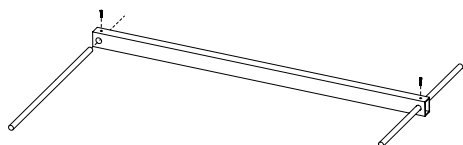

2. Take the aluminium tube and put an inox rod in the hole on each side. Fix the rods with a screw M6x30.

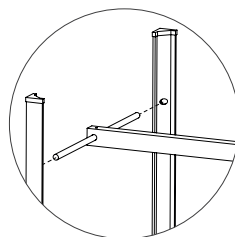

3. Take 1 left and 1 right leg and put the inox rod in the holes.

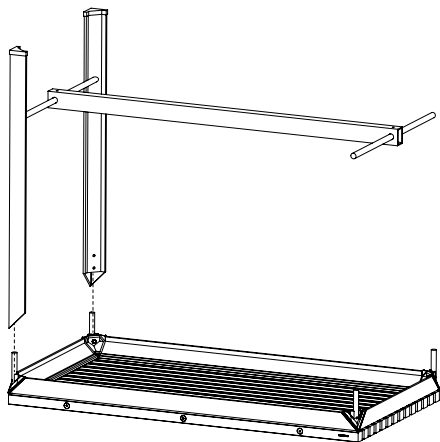

4. Place the legs together on the inox rods of the tables as shown on the picture. Repeat the last 2 actions for the other side of the table.

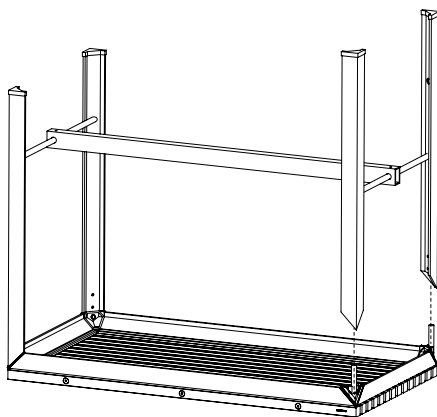

5. Fix the 4 legs by tightening the screws. The table is then ready. Turn it upside down.

## OPTIONAL FLOOR FASTENING

### WHAT YOU NEED



2 people



no. 13 spanner



no. 4 hex key



+/- 15 min.

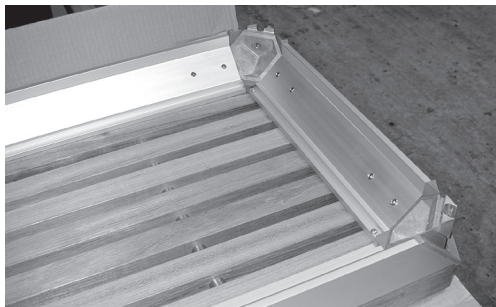

1. Put the table or the bench on the ground with the wooden side facing downwards. Use the packaging material to protect the wooden surface.



2. Insert the 4 identical stainless steel rods into the holes provided for that purpose.

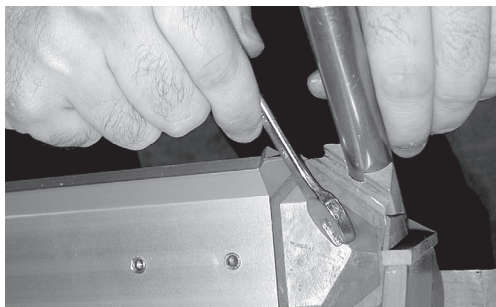

3. Screw down the rods using a no. 13 wrench. Do not tighten them too much as this may cause them to break.



4. Put the table or the bench (without fitting the legs) on the spot where you intend to fasten it to the ground.

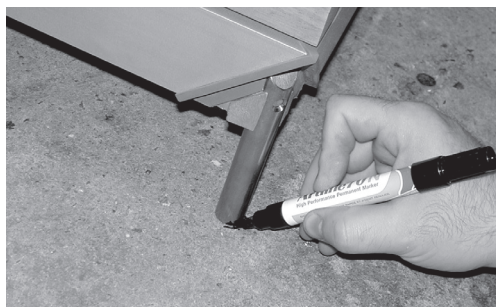

5. Mark the spots where the rods touch the ground. Then move the table or the bench and fit the legs as explained in the Extemporal manual.



6. Drill holes (Ø 12 mm) in the ground at the marked spots. The depth of the drill holes must correspond to the size of the plugs. They may not protrude above the ground.



7. Screw down the supplied stainless steel axles with coach screws. Make sure that the stainless steel axles are perfectly straight.

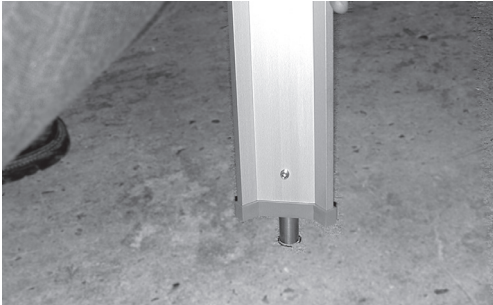

8. Now put the legs of the table or the bench over the protruding stainless steel axles.



9. Tighten the little screws at the bottom of each leg.

## MAINTENANCE

### JATOBA

Jatoba wood requires little or no maintenance. However, we strongly advise you to remove persistent dirt. To clean the wood you can use special products ([www.rmc-extremis.be](http://www.rmc-extremis.be)) or simply a stiff bristle brush and some water. Be careful not to irreparably damage the wood fibres. For this reason, **never use a high pressure cleaner** as this will roughen the wood's smooth surface and irreparably damage the wood's fibres.

At first, the wood will give off this red dye every time it comes into contact with water. The dye that drips onto the frame and the surface will remain water-soluble and will disappear entirely after a while.

**We strongly recommend that you treat your wood for indoor use with wood oil to protect it from stains.**

When delivered, the wooden parts of our products are **untreated**. Exposure to sun and rain will gradually change their colour to silvery grey, and also roughen the surface. If you want to somewhat retain their original colour, you should oil them once a year. We recommend using **RMC Hybrid Wood Protector** ([www.rmc-extremis.com](http://www.rmc-extremis.com)). RMC products for wood treatment are available all over the world. Visit the website [www.rmc-extremis.com](http://www.rmc-extremis.com) to find a reseller near you.

### IMPORTANT!

Wood is a living matter and, in spite of the superior quality provided by jatoba, outdoors it constantly has to adapt to extreme changes in temperature and humidity. Due to internal stress resulting from these constant adaptations the wood "warps". This warping can among other things lead to cracking. Changes in colour or wood structure may also appear. These characteristics are typical of the material and by choosing this material you accept them.

Should any cracks appear, you can simply sand them down either by hand using sandpaper or by means of a hand sander. To protect any galvanised or painted parts, cover the edges with highly robust masking tape. Use 80-grit sandpaper and start at the vertical side of the tabletop. Keep the hand sander parallel to the edge of the tabletop. Lightly sand the edge until it is smooth again. Now sand the rest of the tabletop. Make sure that you always hold the hand sander parallel to the tabletop. Do not only sand the crack, but the entire tabletop to obtain a uniform result. To avoid burrs, sand the top edge of the tabletop by hand. When you have removed all the burrs, you can treat the wood with hardwood furniture oil or leave it untreated, depending on the desired effect.

### ALUMINIUM

The profiles used for our "ExTempore" range are made of extruded and anodised aluminium. Anodising is a process aimed at thickening the existing aluminium oxide layer, which protects the aluminium from rusting. We have opted not to submit the aluminium to any further treatment as this does not alter its life span and is moreover very harmful to the environment. It is therefore possible that the profiles present minor scratches or scores, resulting from the production process. These do not in any way detract from the material's durability. The profiles require little maintenance. Cleaning them with lukewarm water and a mild detergent once or twice a year is sufficient.

### STAINLESS STEEL

Although stainless steel has its own oxidation layer protecting the steel from rust, it remains necessary to regularly remove deposit and dirt from the steel with a dry cloth and some stainless steel cleaner. If damaged, the oxidation layer cannot always repair itself completely. A maritime climate, bleach, acid rain, an aggressive industrial or urban environment seriously damage the material. They determine the frequency and the necessity of the surface cleaning. The appropriate cleaning products are readily available. Steel will however only remain rustproof if it is covered by the oxidation layer. Consequently, you must prevent the formation of a permanent layer of dirt, especially in case of aggressive environmental factors.





## LANGUAGES

### ENGLISH P. 3

contents .....	p. 3
assembly extempore bench extra high .....	p. 4
assembly extempore table extra high .....	p. 5
assembly optional floor fastening .....	p. 6
maintenance .....	p. 8

### NEDERLANDS P. 11

inhoud .....	p. 11
montage extempore bank extra hoog .....	p. 12
montage extempore tafel extra hoog .....	p. 13
montage optionele grondverankering .....	p. 14
onderhoud .....	p. 16

### DEUTSCH P. 19

inhalt .....	p. 19
montage extempore bank extra hoch .....	p. 20
montage extempore tisch extra hoch .....	p. 21
montage optional bodenverankerung .....	p. 22
pflege .....	p. 24

### FRANÇAIS P. 27

contenu .....	p. 27
montage extempore banc haut .....	p. 28
montage extempore table extra haute .....	p. 29
montage ancrage au sol en option .....	p. 30
entretien .....	p. 32

### ITALIANO P. 35

contenuto .....	p. 35
montaggio extempore panca alta .....	p. 36
montaggio extempore tavolo extra alto .....	p. 37
montaggio ancoraggio al suolo opzionale .....	p. 38
manutenzione .....	p. 40

### ESPAÑOL P. 43

contenido .....	p. 43
montage extempore banco alto .....	p. 44
montage extempore mesa extra alta .....	p. 45
montage anclaje al suelo opcional .....	p. 46
mantenimiento .....	p. 48

## INHOUD

### BANK EXTRA HOOG

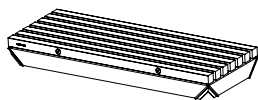

1 x bank



4 x poten



4 x montage-stangen

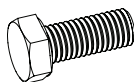

4 x bouten M8x25



1 x inox buis

---

### TAFEL EXTRA HOOG

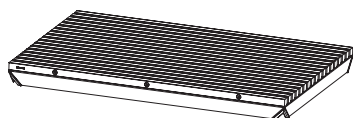

1 x tafelblad



4 x poten



4 x montage-stangen

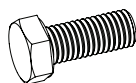

4 x bouten M8x25

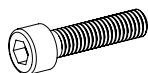

2 x boutjes M6x30



1 x alu buis



2 x inox buis

---

## OPTIONEEL

### GRONDVERANKERING



4 x inox asje

# MONTAGE EXTEMPORE BANK EXTRA HOOG

## BENODIGDHEDEN



2 personen



steeksleutel nr. 13



inbussleutel nr. 4



+/- 15 min.



1. Leg de bank omgekeerd (met het hout naar beneden). Gebruik de verpakking als bescherming.

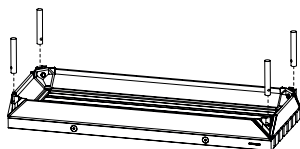

2. Steek de 4 montagestangen in de voorziene gaten van de 4 hoekstukken. Zet de stangen vast met behulp van de 4 bouten en een steeksleutel nr 13. Let er op dat de bouten niet te hard worden aangespannen, dit kan de bout breken.

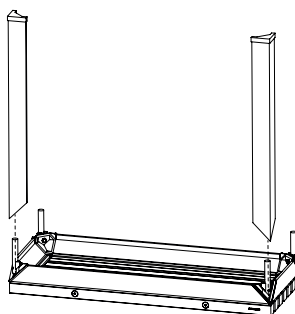

3. Plaats een poot zonder gat over de gemonteerde stang. Span de schroeven M8x25 aan, en herhaal dit voor de andere hoek aan diezelfde lange zijde.

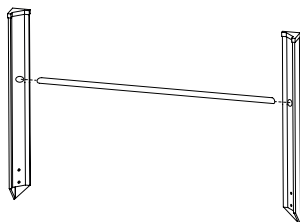

4. Plaats de inox buis in de gaten tussen de 2 resterende poten.

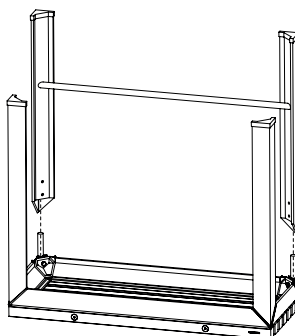

5. Plaats de 2 poten over de overblijvende stangen en schroef ze vast. De bank is nu klaar, draai ze om.

# MONTAGE EXTEMPORE TAFEL EXTRA HOOG

## BENODIGDHEDEN



2 personen



steeksleutel nr. 13



inbussleutel nr. 4



+/- 15 min.

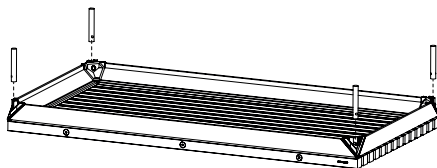

1. Leg de bank omgekeerd (met het hout naar beneden). Gebruik de verpakking als bescherming. Steek de 4 montagestangen in de voorziene gaten van de 4 hoekstukken. Zet de stangen vast met behulp van de 4 bouten en een steeksleutel nr 13. Let er op dat de bouten niet te hard worden aangespannen, dit kan de bout breken.

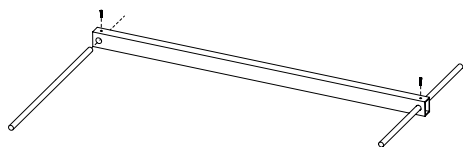

2. Neem de alu buis en plaats een inoxstaaf in het gat aan beide zijden. Fixeer de inox staven met een schroef M6x30.

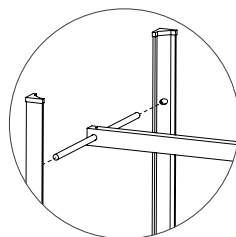

3. Neem 1 rechtste en 1 linkse poot, en voeg de inox staaf in de voorziene gaten.

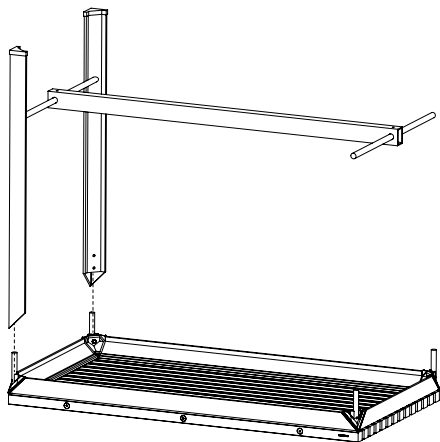

4. Plaats beide poten samen op de stangen van de tafel (zoals op de afbeelding). Herhaal de laatste 2 stappen voor de andere zijden.

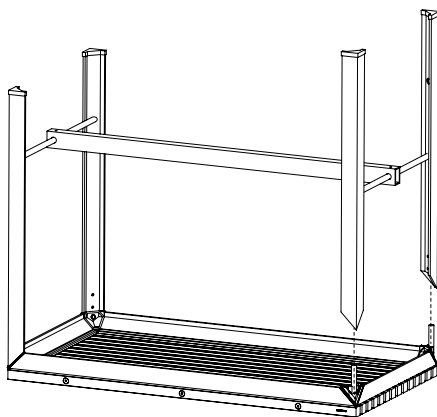

5. Schroef de poten vast door de schroeven aan te spannen. Tafels is klaar, terug omdraaien.

## OPTIONELE GRONDVERANKERING

### BENODIGDHEDEN



2 personen



steeksleutel nr. 13



inbussleutel nr. 4



+/- 15 min.



1. Leg de bank of tafel ondersteboven op de grond (met het houtgedeelte op de grond). maak gebruik van het verpakkingsmateriaal om het hout te beschermen.



2. Breng de 4 gelijke staven aan in de voorziene gaten aan de vier hoeken.

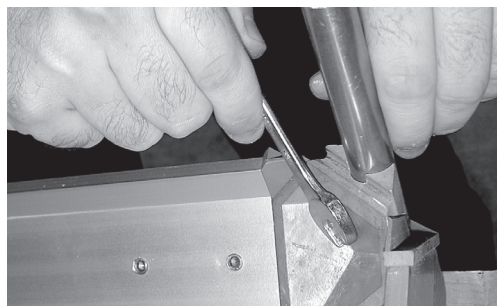

3. Schroef de staven vast, door gebruik van de moersleutel nr 13. Schroef ze niet te hard aan, dit kan ze doen breken.

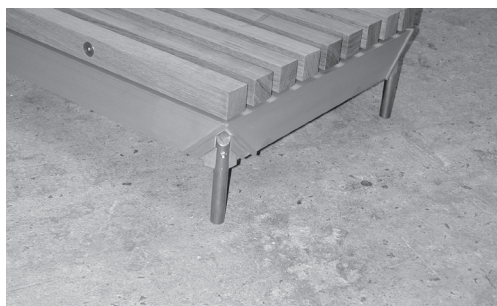

4. Plaats de tafel of bank (zonder de poten te bevestigen) op de plaats waar je de bank of tafel wil bevestigen.



5. Duid aan waar de staven de grond raken. Verplaats bank of tafel wanneer je hiermee klaar bent. Bevestig de poten zoals uitgelegd in de ExTempore handleiding.



6. Voorzie de boorgaten (Ø 12 mm) in de grond waar u ze hebt aangeduid. Maak dat de gaten voldoende diep zijn zodat de pluggen volledig in de grond passen.



7. Bevestig nu de bijgeleverde inox asjes door ze vast te bouwen met houtschroefbouten. Zorg ervoor dat het inox asje mooi recht staat.

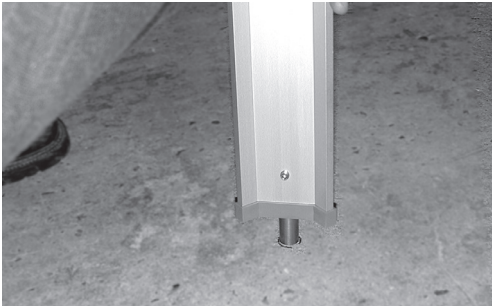

8. Nu kun je de poten van de tafel of bank over de inox asjes plaatsen die uit de grond steken.



9. Schroef de kleine schroeven onderaan elke poot vast.

## ONDERHOUD

### JATOBA

Jatoba vraagt weinig tot geen onderhoud. Wij raden u echter wel aan om hardnekkige vuilresten te verwijderen. Om het hout te reinigen, kunt u speciale producten ([www.rmc-extremis.be](http://www.rmc-extremis.be)) gebruiken of gewoon een harde borstel en wat water. Zorg er echter voor dat u de houtvezels niet beschadigt. Gebruik daarom nooit een hogedrukreiniger. Hierdoor wordt het gladde oppervlak van het hout immers ruwer en raken de houtvezels onherstelbaar beschadigd.

Zoals vele andere houtsoorten bevat Jatoba een wateroplosbare gomstof. In het begin zal het hout deze fel rode kleurstof afscheiden telkens het met water in contact komt. De op het onderstel en de ondergrond afgedropen kleurstof blijft wateroplosbaar en zal na zekere tijd volledig verdwijnen.

**We raden ten sterkste aan het hout voor binnen gebruik in te oliën tegen vlekken.**

Bij levering zijn de houten onderdelen van onze producten onbehandeld. Door blootstelling aan zonlicht en regen zullen ze geleidelijk een grijs patina krijgen en zal hun oppervlak ook ruwer worden. Als u de oorspronkelijke kleur min of meer wilt behouden, moet u ze jaarlijks oliën. Hiervoor raden wij RMC Hybrid Wood Protector ([www.rmc-extremis.com](http://www.rmc-extremis.com)) aan. De houtbeschermingsproducten van RMC zijn overal ter wereld verkrijgbaar. Kijk op [www.rmc-extremis.com](http://www.rmc-extremis.com) voor een verkooppunt in uw buurt.

### BELANGRIJK!

Hout is een levende materie, en ondanks de superieure kwaliteiten van Iroko, moet het zich buiten steeds aanpassen aan extreme schommelingen van temperatuur en vochtigheid. Hierdoor opgebouwde interne spanningen doet het materiaal “werken” of vervormen en kan er mogelijk o.a. scheurvorming veroorzaken. Ook kunnen er kleur- en structuurverschillen voorkomen.

Deze kenmerken zijn typisch voor het materiaal, die u door uw keuze hiervoor accepteert.

U kan mogelijke scheuren eenvoudig glad schuren met de hand en een vel schuurpapier of met een handschuurmachine. Om de gegalvaniseerde of gelakte onderdelen te beschermen, moet u hun randen vooraf afplakken met stevige afplakband. Gebruik schuurpapier met korrel 80 en begin bij de verticale zijde van het tafelblad. Houd de machine evenwijdig aan de tafelrand. Schuur lichtjes tot de rand weer egaal glad is. Schuur nu het bovenblad. Let er op dat u de machine evenwijdig aan het tafelblad houdt. Behandel niet enkel de gescheurde plaats, maar gans uw blad om een egaal resultaat te bekomen. Om bramen te vermijden schuurt u de bovenste rand van het tafelblad glad. Doe dit deel met de hand. Als alle bramen verwijderd zijn kan u, afhankelijk van het gewenste effect, de tafel inoliën met hardhout olie.

### ALUMINIUM

De profielen van het ExTempore gamma bestaan uit geëxtrudeerde en geanodiseerde aluminium. Anodisatie is een proces waarbij men de aluminiumoxi-delaag, die het aluminium beschermt tegen corrosie, nog gaat verdikken. We hebben gekozen om het aluminium niet verder te behandelen, omdat dit de levensduur niet verbetert, en bovendien altijd sterk milieubelastend is. Hierdoor is het mogelijk dat er wel nog kleine krassen of strepen zichtbaar zijn op de profielen, welke eigen zijn aan het productieproces, maar dit doet zeker geen enkele afbreuk aan de duurzaamheid van het materiaal. De profielen vragen verder weinig onderhoud. Een eenvoudige reiniging met lauwwater en wat reinigingsmiddel volstaat één of twee keer per jaar.

### ROESTVAST STAAL

Alhoewel roestvast staal een eigen oxidatielaag heeft die het staal beschermt tegen roesten is het toch nodig om geregeld aanslag en vuil te verwijderen met een droge vod en roestvrij staalreiniger. De oxidatielaag kan zich namelijk bij beschadiging niet altijd volledig herstellen. Het zeeklimaat, chloor, zure regen, een agressieve industriële of stedelijke omgeving zijn zwaar belastende factoren voor het materiaal. Deze bepalen regelmaat en noodzaak van oppervlaktereiniging, waarvoor de gepaste middelen algemeen verkrijgbaar zijn.





## LANGUAGES

### ENGLISH P. 3

contents .....	p. 3
assembly extempore bench extra high .....	p. 4
assembly extempore table extra high .....	p. 5
assembly optional floor fastening .....	p. 6
maintenance .....	p. 8

### NEDERLANDS P. 11

inhoud .....	p. 11
montage extempore bank extra hoog .....	p. 12
montage extempore tafel extra hoog .....	p. 13
montage optionele grondverankering .....	p. 14
onderhoud .....	p. 16

### DEUTSCH P. 19

inhalt .....	p. 19
montage extempore bank extra hoch .....	p. 20
montage extempore tisch extra hoch .....	p. 21
montage optional bodenverankerung .....	p. 22
pflege .....	p. 24

### FRANÇAIS P. 27

contenu .....	p. 27
montage extempore banc haut .....	p. 28
montage extempore table extra haute .....	p. 29
montage ancrage au sol en option .....	p. 30
entretien .....	p. 32

### ITALIANO P. 35

contenuto .....	p. 35
montaggio extempore panca alta .....	p. 36
montaggio extempore tavolo extra alto .....	p. 37
montaggio ancoraggio al suolo opzionale .....	p. 38
manutenzione .....	p. 40

### ESPAÑOL P. 43

contenido .....	p. 43
montage extempore banco alto .....	p. 44
montage extempore mesa extra alta .....	p. 45
montage anclaje al suelo opcional .....	p. 46
mantenimiento .....	p. 48

## INHALT

### BANK EXTRA HOCH

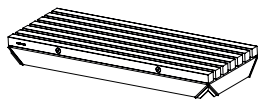

1 x Bank



4 x Beine



4 x Montagestangen

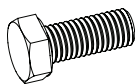

4 x Schraube M8x25



1 x Edelstahlstange

---

### TISCH EXTRA HOCH

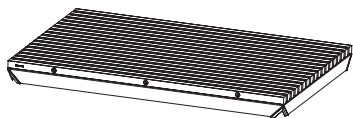

1 x Tischplatte



4 x Beine



4 x Montagestangen

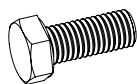

4 x Schraube M8x25

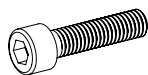

2 x Schraube M6x30



1 x Aluminium stange



2 x Edelstahlstange

---

## OPTIONAL

### BODENVERANKERUNG



4 x inox Achsen

# MONTAGE EXTEMPORE BANK EXTRA HOCH

## WAS SIE BRAUCHEN



2 Personen



Maulschlüssel Nr. 13



Inbusschlüssel Nr. 4



+/- 15 min.

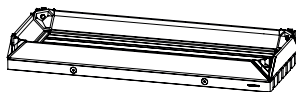

1. Legen Sie die Bank umgekehrt (mit dem Holz nach unten). Verwenden Sie die Verpackung zum Schutz.

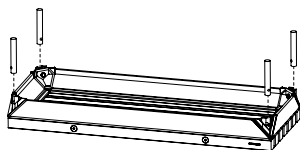

2. Stecken Sie die 4 Montagestangen in die dafür vorgesehenen Löcher der 4 Eckstücke. Befestigen Sie die Stangen, indem Sie die 4 Bolzen mit einem Schlüssel Nr. 13 festdrehen. Achte darauf, dass Sie die Bolzen nicht zu fest anziehen, da sonst die Bolzen brechen können.

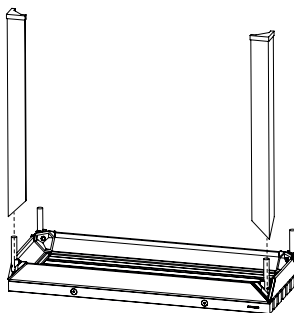

3. Ein Bein ohne Loch auf die stange montieren. Die Schrauben fest anziehen und diesen Vorgang für das andere Eckstück an derselben Längsseite wiederholen.

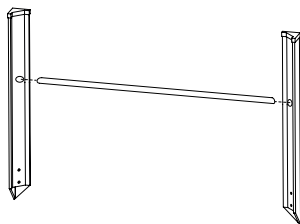

4. Das Edelstahlrohr in die Löcher der 2 übrigen Beine einsetzen.

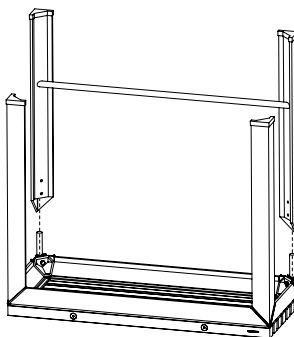

5. Die Beine auf die Edelstahlstangen montieren und festschrauben. Die Bank ist nun fertig montiert. Auf die andere Seite drehen

# MONTAGE EXTEMPORE TISCH EXTRA HOCH

## WAS SIE BRAUCHEN



2 Personen



Maulschlüssel Nr. 13



Inbusschlüssel Nr. 4



+/- 15 min.

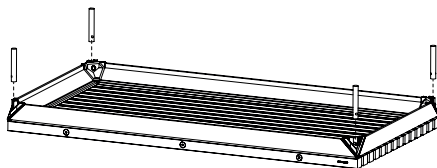

1. Legen Sie die Tischplatte umgekehrt (mit dem Holz nach unten). Verwenden Sie die Verpackung zum Schutz. Stecken Sie die 4 Montagestangen in die dafür vorgesehenen Löcher der 4 Eckstücke. Befestigen Sie die Stangen, indem Sie die 4 Bolzen mit einem Schlüssel Nr. 13 festdrehen. Achte darauf, dass Sie die Bolzen nicht zu fest anziehen, da sonst die Bolzen brechen können.

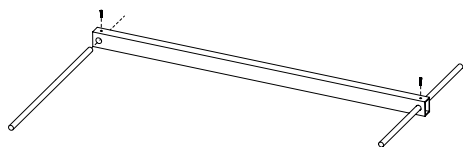

2. Das Aluminiumrohr nehmen und in das Loch an jeder Seite eine Edelstahlstange einsetzen. Die Stangen mit einer M6 x 30 Schraube fest anziehen.

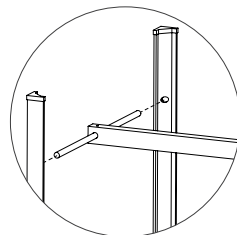

3. 1 linkes und 1 rechtes Bein nehmen und die Edelstahlstange in die Löcher einsetzen.

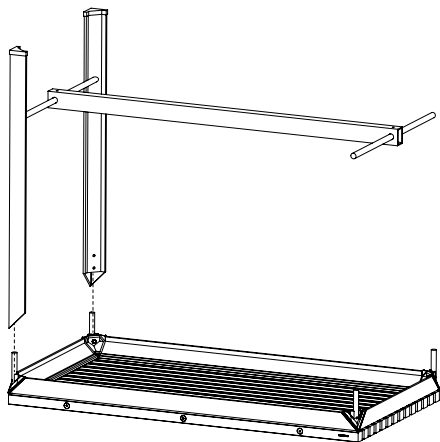

4. Die Beine gemäß der Abbildung zusammen auf die Edelstahlstangen des Tisches montieren. Die 2 letzten Vorgänge an der anderen Seite.

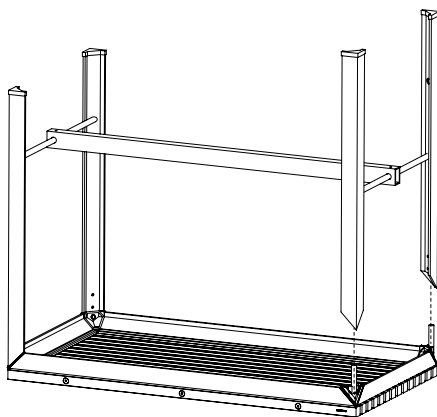

5. Die 4 Beine festschrauben. Der Tisch ist nun fertig montiert. Auf die andere Seite drehen.

## OPTIONAL BODENVERANKERUNG

### WAS SIE BRAUCHEN



2 Personen



Maulschlüssel Nr. 13



Inbusschlüssel Nr. 4



+/- 15 min.

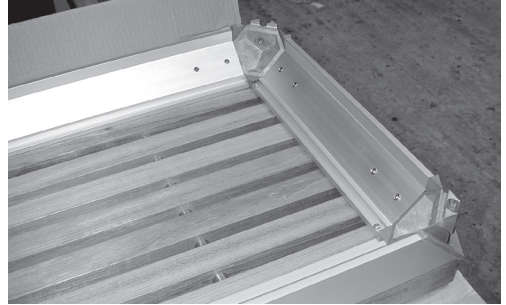

1. Legen Sie die Bank oder den Tisch umgekehrt (= mit dem Holzteil) auf den Boden. Benutzen Sie das Verpackungsmaterial zum Schutz des Holzes.



2. Stecken Sie die 4 Stäbe in die Löcher an den vier Ecken.

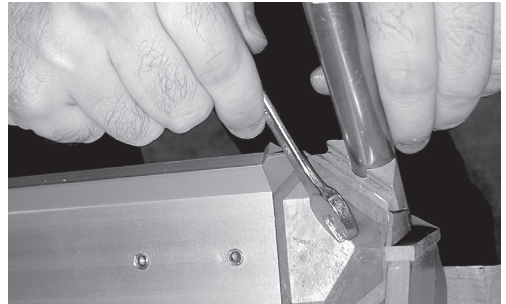

3. Schrauben Sie die Stäbe mit Mutternschlüssel Nr. 13 fest. Nicht zu fest anziehen, die Stäbe können brechen.



4. Stellen Sie den Tisch oder die Bank (ohne die Beine zu befestigen) an die Stelle, an der Sie die Bank oder den Tisch befestigen möchten.



5. Markieren Sie die Stelle, an der die Stäbe auf den Boden treffen. Stellen Sie die Bank oder den Tisch an einer anderen Stelle, wenn Sie hiermit fertig sind. Befestigen Sie die Tischbeine wie in der ExTempore Gebrauchsanweisung beschrieben.



6. Machen Sie an der Stelle, an der Sie die Markierungen angebracht haben, Bohrlöcher ( $\varnothing$  12 mm) im Boden. Sorgen Sie dafür, dass die Löcher ausreichend tief sind, damit die Dübel vollständig in den Boden passen.



7. Befestigen Sie jetzt die mitgelieferten Inox Achsen, indem Sie sie mit Holzschraubenbolzen festschrauben. Sorgen Sie dafür, dass die Inox Achsen schön aufrecht stehen.

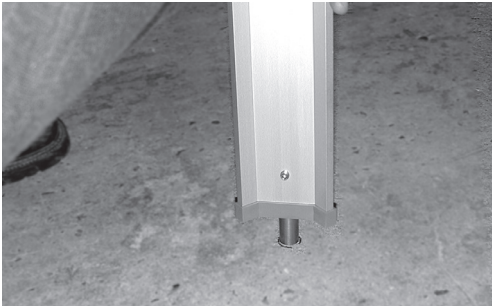

8. Jetzt können Sie die Tisch- oder Bankbeine über die aus dem Boden ragenden Inox Achsen schieben.



9. Schrauben Sie die unteren kleinen Schrauben an jedem Bein fest.

## PFLEGE

### JATOBA

Jatoba benötigen wenig oder gar keine Pflege. Wir empfehlen Ihnen jedoch nachdrücklich, anhaftenden Schmutz zu entfernen. Zur Reinigung des Holzes können Sie Spezialprodukte ([www.rmc-extemis.be](http://www.rmc-extemis.be)) oder einfach nur eine harte Bürste und etwas Wasser verwenden. Achten Sie darauf, die Holzfasern nicht irreparabel zu beschädigen. Aus diesem Grund sollten Sie **niemals einen Hochdruckreiniger verwenden**, da dadurch die glatte Oberfläche des Holzes aufgeraut wird und die Holzfasern irreparabel beschädigt werden.

Am Anfang kann das Holz, wenn es mit Wasser in Kontakt kommt, diesen hellroten Farbstoff ausscheiden. Der auf das Gestell und die Unterfläche getropfte Farbstoff ist nach wie vor wasserlöslich und ist nach einiger Zeit völlig verschwunden.

**Wir raten unbedingt dazu, das Holz für die Verwendung in Innenräumen zum Schutz vor Flecken einzuölen.**

Bei der Lieferung sind die Holzteile unserer Produkte unbehandelt. Wenn sie Sonne und Regen ausgesetzt sind, werden sie mit der Zeit eine silbergraue Farbe annehmen und ihre Oberfläche wird rauer. Wenn Sie ihre ursprüngliche Farbe zu einem gewissen Grad bewahren wollen, sollten Sie sie einmal jährlich ölen. Wir empfehlen die Verwendung von **RMC Hybrid Wood Protector** ([www.rmc-extemis.be](http://www.rmc-extemis.be)). RMC-Produkte zur Holzbehandlung sind weltweit erhältlich. Auf der Webseite [www.rmc-extemis.com](http://www.rmc-extemis.com) finden Sie einen Händler in Ihrer Nähe

### WICHTIG!

Jatobaholz ist ein lebendes Material, das sich trotz seiner vorzüglichen Eigenschaften ständig an extreme Temperatur- und Feuchtigkeitsschwankungen anzupassen hat, was für Spannungen im Holz sorgt. Aufgrund dieser Spannungen fängt das Holz zu „arbeiten“ an, was zu Rissen sowie Farb- und Strukturunterschieden führt. Diese Eigenschaften sind charakteristisch für das Material.

Wenn Sie sich für diese Holzart entscheiden, müssen Sie diese Eigenschaften einfach in Kauf nehmen.

Eventuelle Risse können Sie einfach mit der Hand und einem Blatt Schleifpapier oder mit einer Handschleifmaschine abschleifen. Um verzinkte und gestrichene Teile zu schützen, decken Sie die Kanten mit sehr robustem Abdeckband. Verwenden Sie Schleifpapier mit 80er Körnung und beginnen Sie an der senkrechten Seite der Tischplatte. Halten Sie die Maschine plan an den Tischrand. Leicht anschleifen, bis der Rand wieder gleichmäßig glatt ist. Danach die Oberseite der Tischplatte schleifen. Achten Sie darauf, dass Sie die Maschine plan auf die Tischplatte aufsetzen. Schleifen Sie nicht nur die gerissene Stelle, sondern die gesamte Platte, um ein gleichmäßiges Ergebnis zu erzielen. Um Grate zu vermeiden, schleifen Sie den oberen Rand der Tischplatte glatt. Schleifen Sie diesen Teil mit der Hand. Wenn alle Grate entfernt sind, können Sie den Tisch je nach gewünschtem Effekt mit Hartholzöl einölen.

### ALUMINIUM

Die Profile des ExTempore-Sortiments bestehen aus extrudiertem und anodisiertem Aluminium. Anodisation ist ein Verfahren, bei dem die bestehende Aluminiumoxidschicht, die das Aluminium vor Korrosion schützt, noch verstärkt wird. Wir haben uns dazu entschieden, das Aluminium nach der Anodisation nicht weiter zu behandeln, da dies die Lebensdauer des Aluminiums nicht verbessert und außerdem besonders umweltbelastend ist. Hierdurch ist es möglich, dass auf den Profilen noch kleine Kratzer oder Striche sichtbar sind, die dem Produktionsverfahren zu verdanken sind. Diese beeinträchtigen die Dauerhaftigkeit des Materials aber nicht. Die Profile sind ferner äußerst pflegeleicht. Sie brauchen sie nur ein oder zwei Mal im Jahr mit lauem Wasser und etwas Reinigungsmittel zu reinigen.

### EDELSTAHL

Obwohl Edelstahl über eine eigene Oxidationsschicht verfügt, die den Stahl vor dem Verrosten schützt, ist es empfehlenswert, Ansatz und Schmutz regelmäßig mit einem Trockenlappen und etwas Edelstahlpflege von die Profile zu entfernen. Die Oxidationsschicht erholt sich im Falle von Beschädigung nämlich manchmal nur zum Teil. Das Meeresklima, Chlor, saurer Regen oder eine aggressive industrielle oder städtische Umgebung belasten das Material sehr. Diese Faktoren bestimmen denn auch wann und wie oft die Oberfläche zu reinigen ist. Die für diese Reinigung angemessenen Produkte sind übrigens überall erhältlich.





## LANGUAGES

### ENGLISH P. 3

contents .....	p. 3
assembly extempore bench extra high .....	p. 4
assembly extempore table extra high .....	p. 5
assembly optional floor fastening .....	p. 6
maintenance .....	p. 8

### NEDERLANDS P. 11

inhoud .....	p. 11
montage extempore bank extra hoog .....	p. 12
montage extempore tafel extra hoog .....	p. 13
montage optionele grondverankering .....	p. 14
onderhoud .....	p. 16

### DEUTSCH P. 19

inhalt .....	p. 19
montage extempore bank extra hoch .....	p. 20
montage extempore tisch extra hoch .....	p. 21
montage optional bodenverankerung .....	p. 22
pflege .....	p. 24

### FRANÇAIS P. 27

contenu .....	p. 27
montage extempore banc haut .....	p. 28
montage extempore table extra haute .....	p. 29
montage ancrage au sol en option .....	p. 30
entretien .....	p. 32

### ITALIANO P. 35

contenuto .....	p. 35
montaggio extempore panca alta .....	p. 36
montaggio extempore tavolo extra alto .....	p. 37
montaggio ancoraggio al suolo opzionale .....	p. 38
manutenzione .....	p. 40

### ESPAÑOL P. 43

contenido .....	p. 43
montage extempore banco alto .....	p. 44
montage extempore mesa extra alta .....	p. 45
montage anclaje al suelo opcional .....	p. 46
mantenimiento .....	p. 48

## CONTENU

### BANC HAUT

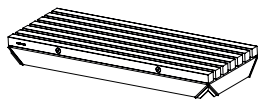

1 x banc



4 x pieds



4 x barres de montage

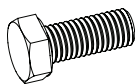

4 x boulon M8x25



1 x inox tube

---

### TABLE EXTRA HAUTE

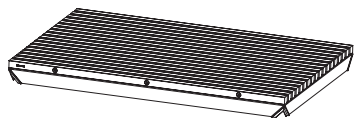

1 x plateau de table



4 x pieds



4 x barres de montage

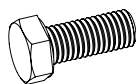

4 x boulon M8x25

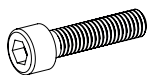

2 x boulon M6x30



1 x alu tube



2 x inox tube

---

## EN OPTION

### ANCRAGE AU SOL



4 x goupille en inox

## MONTAGE EXTEMPORE BANC HAUT

### OUTILS



2 personnes



clé plate n° 13



clé Allen n° 4



+/- 15 min.

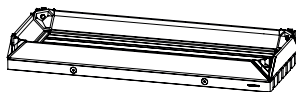

1. Retournez le banc à l'envers sur le sol (avec la partie en bois vers le sol), en vous servant de l'emballage comme protection.

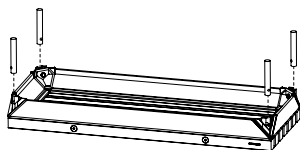

2. Insérez les 4 barres de montage dans les trous prévus à cet effet dans les 4 éléments angulaires. Fixez les barres à l'aide des 4 boulons et de la clé n° 13. Veillez à ne pas trop serrer les boulons sinon les boulons peuvent se rompre.

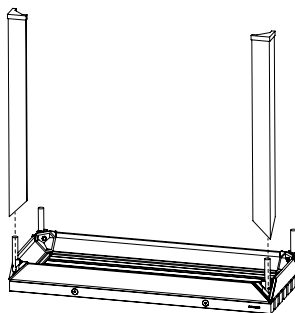

3. Placez une patte, sans trou, au-dessus de la tige en acier inoxydable. Serrez les vis et répétez cette opération pour l'autre coin du même côté long.

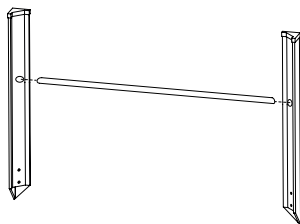

4. Insérez un tube en acier inoxydable dans les trous des 2 pattes restantes.

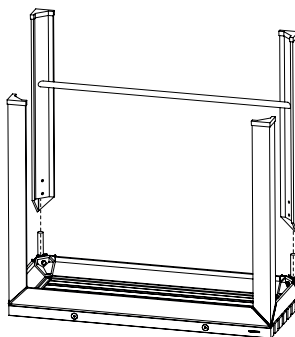

5. Placez les pattes au-dessus des tiges en acier inoxydable et fixez-les en serrant les vis. Le banc est prêt. Remettez-le à l'endroit.

## MONTAGE EXTEMPORE TABLE EXTRA HAUTE

### OUTILS



2 personnes



clé plate n° 13



clé Allen n° 4



+/- 15 min.

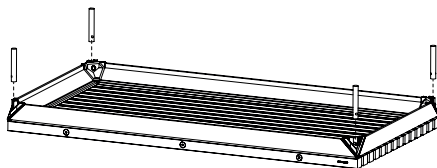

1. Retournez le plateau de table à l'envers sur le sol (avec la partie en bois vers le sol), en vous servant de l'emballage comme protection. Insérez les 4 barres de montage dans les trous prévus à cet effet dans les 4 éléments angulaires. Fixez les barres à l'aide des 4 boulons et de la clé n° 13. Veillez à ne pas trop serrer les boulons sinon les boulons peuvent se rompre.

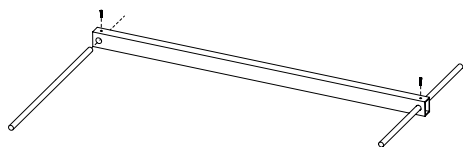

2. Prenez le tube en aluminium et insérez une tige en acier inoxydable dans le trou de chaque côté. Fixez les tiges en acier inoxydable au moyen d'une vis M6 x 30.

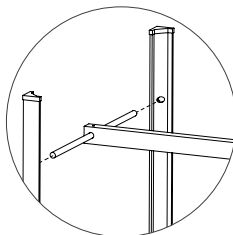

3. Prenez 1 patte gauche et 1 patte droite, et insérez une tige en acier inoxydable dans les trous.

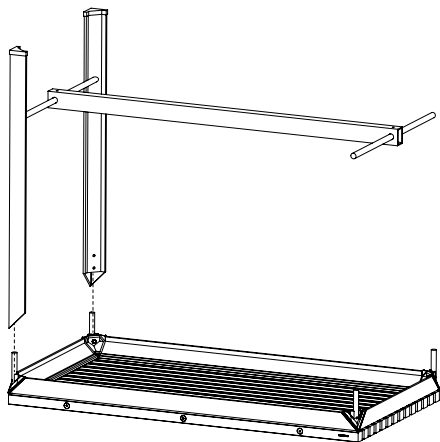

4. Placez les pattes ensemble sur les tiges en acier inoxydable de la table, comme illustré. Répétez les 2 dernières opérations pour l'autre côté.

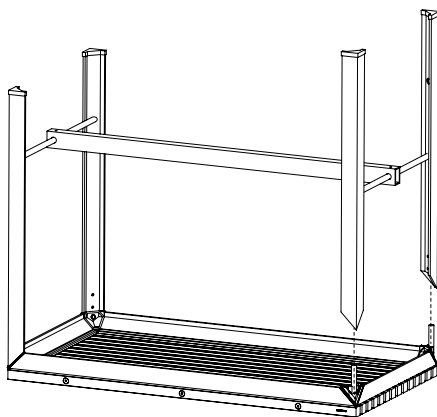

5. Fixez les 4 pattes en serrant les vis. La table est prête. Remettez-la à l'endroit.

## ANCRAGE AU SOL EN OPTION

### OUTILS



2 personnes



clé plate n° 13



clé Allen n° 4



+/- 15 min.

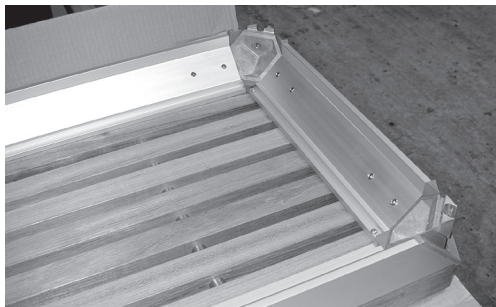

1. Retournez le banc ou la table, côté bois en dessous. Protégez le bois à l'aide de l'emballage.



2. Introduisez les 4 tiges identiques dans les orifices prévus à cet effet.

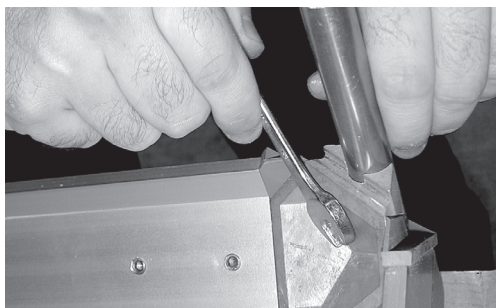

3. Boulonnez les tiges en utilisant une clef n° 13. Ne les boulonnez pas trop sinon vous risquez qu'elles se cassent.



4. Mettez la table ou le banc (sans fixer les pieds) à l'endroit où vous entendez fixer le banc ou la table.



5. Indiquez les points où les tiges tou-chent le sol. Déplacez ensuite le banc ou la table. Fixez les pieds suivant les instructions dans le manuel Extempore.



6. Forez les trous ( $\varnothing$  12 mm) dans le sol aux endroits indiqués. Veillez à ce que la profondeur des trous corresponde a. Aux dimensions des chevilles fournies.



7. Fixez les goupilles en inox fournies à l'aide des tire-fond. Veillez à ce que la goupille soit bien droite.

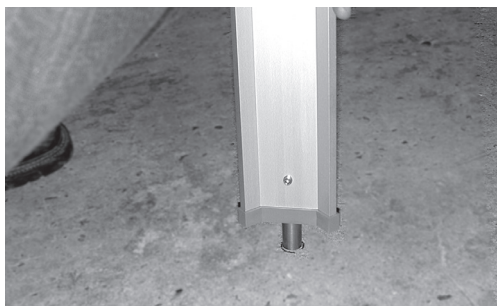

8. Mettez les pieds de la table ou du banc sur les goupilles en inox qui dépassent le sol.



9. Vissez les petites vis en dessous de chaque pied.

## ENTRETIEN

### JATOBA

Les bois Jatoba ne demandent que peu ou pas d'entretien, mais nous recommandons néanmoins fortement d'enlever la saleté persistante. Pour nettoyer le bois, vous pouvez utiliser des produits spéciaux ([www.rmc-extremis.be](http://www.rmc-extremis.be)) ou tout simplement une brosse à poils durs et un peu d'eau. Soyez attentif à ne pas endommager les fibres du bois. **N'utilisez dès lors jamais de nettoyeur à haute pression** car cela rendrait la surface lisse du bois rugueuse et endommagerait irrémédiablement les fibres du bois.

Comme beaucoup d'autres essences, le Iroko contient une gomme soluble à l'eau. Au début, le bois sécrètera ce colorant rouge chaque fois qu'il entre en contact avec l'eau. Le colorant ainsi tombé sur le piétement et sur le sol reste soluble à l'eau et disparaîtra complètement après quelque temps.

**Il est fortement recommandé de huiler le bois à usage intérieur pour le protéger contre les taches.**

À la livraison, les parties en bois de nos produits sont non traitées. L'exposition au soleil et à la pluie modifiera progressivement leur aspect et les rendra grisâtres. Leur surface deviendra aussi plus rugueuse. Si vous souhaitez leur conserver leur couleur d'origine, il faut les huiler une fois par an. Nous recommandons l'utilisation de **RMC Hybrid Wood Protector** ([www.rmc-extremis.com](http://www.rmc-extremis.com)). Les produits d'entretien du bois RMC sont disponibles dans le monde entier. Rendez-vous sur le site Web [www.rmc-extremis.com](http://www.rmc-extremis.com) pour trouver un revendeur dans vos environs

### IMPORTANT !

Le bois est un matériau vivant; bien que Jatoba soit un bois de qualité supérieure, il doit s'adapter à des variations extrêmes de températures et à l'humidité. Cela crée des tensions internes qui font "travailler" le matériau et peuvent causer entre autres des fissures. Des différences de couleur et de structure peuvent aussi apparaître. Ces caractéristiques sont typiques du matériau, et vous les acceptez par votre choix.

Vous pouvez poncer d'éventuelles griffes simplement à la main avec une feuille de papier émeri ou avec une ponceuse manuelle. Protégez les parties galvanisées ou peintes avec du ruban de masquage. Utilisez du papier émeri de grain 80, et commencez sur la face verticale du plateau de table. Tenez la machine parallèlement au bord de la table. Poncez légèrement jusqu'à ce que le bord soit à nouveau parfaitement lisse. Poncez à présent le dessus du plateau. Veillez à tenir la machine bien parallèle au plateau de table. Ne vous limitez pas à la partie griffée mais poncez l'ensemble du plateau afin d'obtenir un résultat égal. Pour éviter les arêtes, lissez l'arête supérieure du plateau. Effectuez cette partie-là à la main. Une fois que toutes les barbes ont été enlevées, vous pouvez, en fonction de l'effet souhaité, huiler la table avec de l'huile pour bois dur.

### L'ALUMINIUM

Les profilés employés dans notre gamme ExTempore sont en aluminium extrudé et anodisé. L'anodisation est le procédé par lequel on épaissit la couche naturelle d'oxyde d'aluminium, qui protège l'aluminium contre la corrosion. Nous avons choisi de ne pas traiter plus l'aluminium, étant donné que cela n'augmente pas sa durée de vie, et que cela est toujours néfaste pour l'environnement. Il est donc possible qu'il reste encore de petites saletés ou des rayures sur nos profilés, provenant du processus de fabrication, mais cela n'entame en rien la solidité du matériau. Les profilés demandent peu d'entretien. Il suffit de les nettoyer à l'eau tiède avec un peu de détergent une ou deux fois par an.

### L'ACIER INOXYDABLE

Bien que l'acier inoxydable possède sa propre couche d'oxydation qui protège l'acier contre la rouille, il faut régulièrement éliminer les dépôts et la saleté qui s'accumulent sur les profils au moyen d'un chiffon sec et d'un nettoyant pour l'acier inoxydable. Si elle est endommagée, la couche d'oxydation risque de ne pas se réparer complètement. Un climat maritime, le chlore, des pluies acides ou un environnement industriel ou urbain agressifs sont des facteurs de lourde charge du matériau. Ils déterminent la fréquence et la nécessité du nettoyage de la surface. Les produits à employer pour ce faire sont en vente partout.





## LANGUAGES

### ENGLISH P. 3

contents .....	p. 3
assembly extempore bench extra high .....	p. 4
assembly extempore table extra high .....	p. 5
assembly optional floor fastening .....	p. 6
maintenance .....	p. 8

### NEDERLANDS P. 11

inhoud .....	p. 11
montage extempore bank extra hoog .....	p. 12
montage extempore tafel extra hoog .....	p. 13
montage optionele grondverankering .....	p. 14
onderhoud .....	p. 16

### DEUTSCH P. 19

inhalt .....	p. 19
montage extempore bank extra hoch .....	p. 20
montage extempore tisch extra hoch .....	p. 21
montage optional bodenverankerung .....	p. 22
pflege .....	p. 24

### FRANÇAIS P. 27

contenu .....	p. 27
montage extempore banc haut .....	p. 28
montage extempore table extra haute .....	p. 29
montage ancrage au sol en option .....	p. 30
entretien .....	p. 32

### ITALIANO P. 35

contenuto .....	p. 35
montaggio extempore panca alta .....	p. 36
montaggio extempore tavolo extra alto .....	p. 37
montaggio ancoraggio al suolo opzionale .....	p. 38
manutenzione .....	p. 40

### ESPAÑOL P. 43

contenido .....	p. 43
montage extempore banco alto .....	p. 44
montage extempore mesa extra alta .....	p. 45
montage anclaje al suelo opcional .....	p. 46
mantenimiento .....	p. 48

## CONTENUTO

### PANCA ALTA

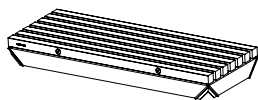

1 x panca



4 x gambe



4 x barre di montaggio

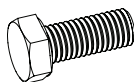

4 x bulloni M8x25



1 x barra inossidabile

---

### TAVOLO EXTRA ALTO

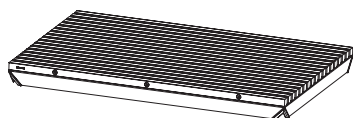

1 x piano del tavolo



4 x gambe



4 x barre di montaggio

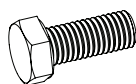

4 x bulloni M8x25

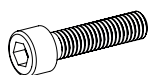

2 x bulloni M6x30



1 x tubo di alluminio



2 x barra inossidabile

---

### OPZIONALE

#### ANCORAGGIO AL SUOLO



4 x asse di acciaio  
inossidabile

## MONTAGGIO EXTEMPORE PANCA ALTA

### NECESSARIO PER IL MONTAGGIO



2 persone



chiave inglese nr. 13



chiave a brugola nr. 4



+/- 15 min.



1. Ribaltare la panca (con il legno sul suolo). Utilizzare il materiale da imballaggio per proteggere la superficie.

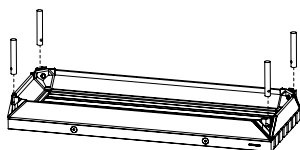

2. Inserire le 4 barre di montaggio negli appositi fori situati negli angoli. Serrare le barre utilizzando i 4 bulloni e la chiave nr. 13. Non serrarli troppo per evitare che si rompano.

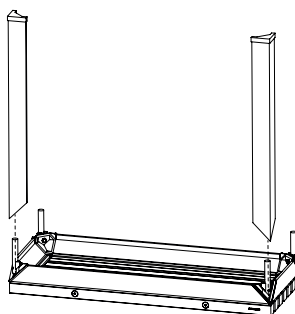

3. Montare una gamba senza foro sulla barra di acciaio inossidabile. Serrare le viti e ripetere la stessa operazione per l'altro angolo del lato lungo della panca.

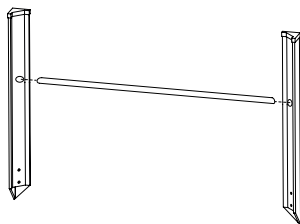

4. Infilare il tubo di acciaio inossidabile nei fori delle due gambe rimanenti.

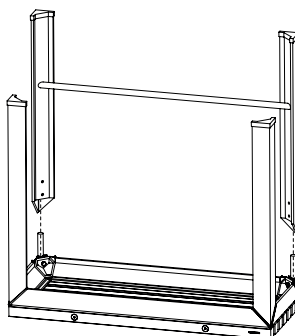

5. Montare le gambe sulle barre di acciaio inossidabile e fissarle avvitando le viti. La panca è pronta per l'uso. Ribaltarla.

## MONTAGGIO EXTEMPORE TAVOLO EXTRA ALTO

### NECESSARIO PER IL MONTAGGIO



2 persone



chiave inglese nr. 13



chiave a brugola nr. 4



+/- 15 min.

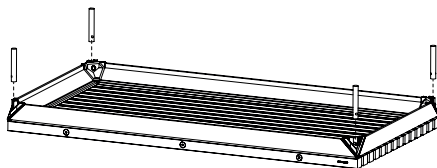

1. Ribaltare il piano del tavolo (con il legno sul suolo). Utilizzare il materiale da imballaggio per proteggere la superficie. Inserire le 4 barre di montaggio negli appositi fori situati negli angoli. Serrare le barre utilizzando i 4 bulloni e la chiave nr. 13. Non serrarli troppo per evitare che si rompano.

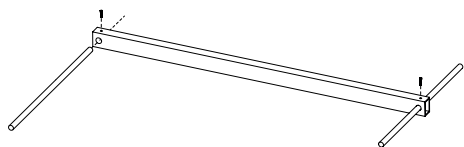

2. Prendere il tubo di alluminio ed infilare un'asta di acciaio inossidabile nel foro ad ogni lato. Fissare le aste di acciaio inossidabile con una vite M6 x 30.

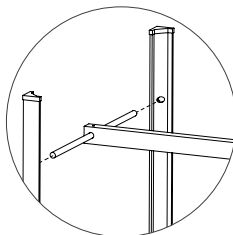

3. Prendere una gamba sinistra e una gamba destra ed infilare l'asta di acciaio inossidabile nei fori.

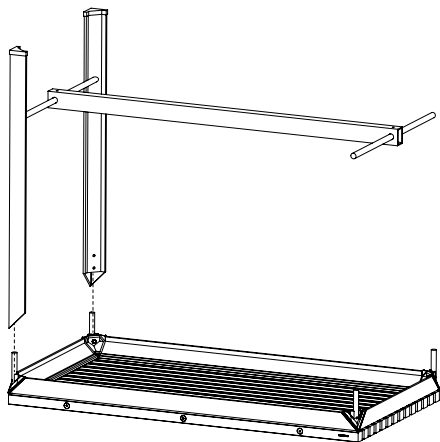

4. Montare le gambe contemporaneamente sulle barre di acciaio inossidabile del tavolo (vedi illustrazione). Ripetere le due ultime operazioni per l'altro lato del tavolo.

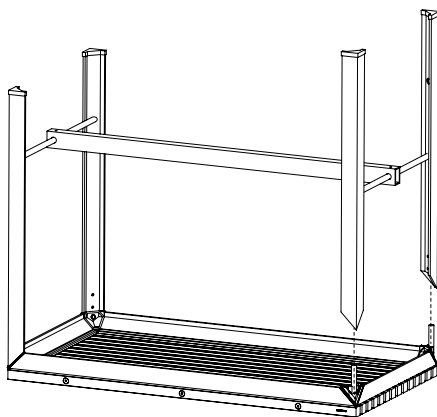

7. Fissare le 4 gambe avvitando le viti. Il tavolo è pronto per l'uso. Ribaltarlo.

## ANCORAGGIO AL SUOLO OPZIONALE

### NECESSARIO PER IL MONTAGGIO



2 persone



chiave inglese nr. 13



chiave a brugola nr. 4



+/- 15 min.



1. Ribaltare la panca / il tavolo (con il legno sul suolo). Utilizzare il materiale da imballaggio per proteggere la superficie di legno.



2. Inserire le 4 barre identiche negli appositi fori situati negli angoli.

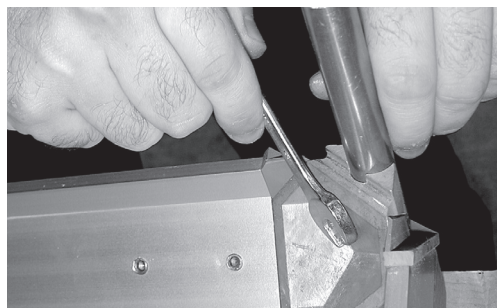

3. Serrare le barre utilizzando la chiave n. 13. Non serrarle troppo per evitare che si rompano.



4. Posizionare il tavolo o la panca (senza montare le gambe) al luogo dove si intende fissare il tavolo o la panca.



5. Contrassegnare i posti dove le barre toccano il suolo. Poi spostare il tavolo o la panca e fissare le gambe secondo le istruzioni nel manuale ExTempore.



6. Forare buchi (Ø 12 mm) nel suolo all'altezza dei contrassegni. La profondità dei buchi deve essere adatta alle dimensioni dei tasselli forniti a corredo. I tasselli non possono emergere dal suolo.



7. Fissare gli assi di acciaio inossidabile forniti a corredo per mezzo dei buloni. Ogni asse di acciaio inossidabile deve essere perfettamente dritto.

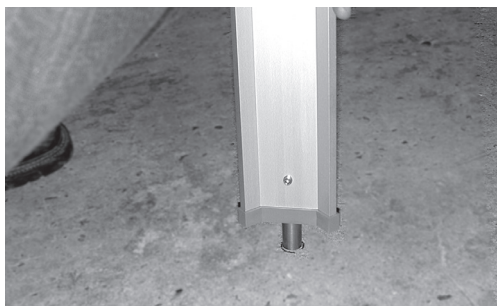

8. Mettere le gambe del tavolo o della panca sugli assi di acciaio inossidabile che emergono dal suolo.



9. Serrare le piccole viti nella parte inferiore di ogni gamba.

## MANUTENZIONE

### JATOBA

Il legno di Jatoba non richiede particolare manutenzione. Tuttavia, consigliamo vivamente di rimuovere lo sporco persistente. Per pulire il legno è possibile utilizzare prodotti specifici ([www.rmc-extremis.be](http://www.rmc-extremis.be)) o semplicemente una spazzola a setole dure con un po' d'acqua. Fare attenzione a non danneggiare irrimediabilmente le fibre del legno. Per evitarlo, **non utilizzare mai un idropulitrice ad alta pressione**, che graffierebbe la superficie liscia del legno danneggiandone irrimediabilmente le fibre.

Come molte altre essenze, la Iroko contiene una gomma idrosolubile. Nel primo tempo dopo l'acquisto questo colorante rosso si libererà ogni volta che la Jatoba entra a contatto con l'acqua. Il colorante sulle gambe e sul suolo resta idrosolubile e sparirà dunque completamente dopo qualche tempo.

**Consigliamo vivamente di oliare il legno da utilizzare all'interno per evitare le macchie.**

Al momento della consegna, le parti in legno dei nostri prodotti sono non trattate. L'esposizione al sole e alla pioggia ne modificherà gradualmente il colore a un grigio argentato, rendendone inoltre ruvida la superficie. Per preservarne il più possibile il colore originale, le parti andrebbero trattate con olio una volta all'anno. Consigliamo di utilizzare il prodotto **RMC Hybrid Wood Protector** ([www.rmc-extremis.com](http://www.rmc-extremis.com)). I prodotti RMC per la cura del legno sono disponibili in tutto il mondo. Per trovare il rivenditore più vicino, visitare il sito web [www.rmc-extremis.com](http://www.rmc-extremis.com)

### IMPORTANTE!

Il legno è un materiale vivo e, nonostante sia un legno di qualità superiore, all'aperto Jatoba deve costantemente adattarsi alle oscillazioni estreme di temperatura e umidità. A causa delle tensioni interne derivanti da questi adattamenti il legno "si deforma" ed è anche possibile che si creino delle crepe. Possono anche determinarsi variazioni nel colore e nella struttura. Queste caratteristiche sono tipiche del materiale: scegliendolo, accettate anche queste possibili variazioni.

Eventuali graffi possono essere eliminati semplicemente a mano utilizzando della carta vetrata oppure servendosi di una levigatrice manuale. Per proteggere le parti galvanizzate o verniciate, coprirne i bordi con scotch di carta molto resistente. Utilizzare carta vetrata a grana 80 iniziando dal lato verticale del piano del tavolo. Tenere la levigatrice in posizione parallela rispetto al bordo del tavolo. Levigare leggermente finché il bordo è di nuovo liscio e omogeneo. Levigare quindi il ripiano. Fare attenzione a mantenere la levigatrice in posizione parallela rispetto alla superficie del tavolo. Per ottenere un risultato uniforme, non trattare soltanto le parti danneggiate, ma l'intera superficie. Per evitare imperfezioni, levigare il bordo superiore del piano del tavolo a mano. Quando tutte le imperfezioni saranno state rimosse, sarà possibile, a seconda dell'effetto desiderato, trattare il tavolo con olio per legno duro.

### ALUMINIO

En nuestra gama «Ex Tempore» utilizamos perfiles de aluminio anodizado y extrudido. El anodizado es un proceso que consiste en incrementar el espesor de la capa de óxido de aluminio existente para evitar que el aluminio se oxide. Hemos optado por no someter el aluminio a ningún tratamiento adicional, pues éstos no alargan su vida útil y, en cambio, son muy perjudiciales para el medio ambiente. Por consiguiente, es posible que los perfiles presenten pequeñas rayadas o muescas, resultantes del proceso de producción, que no afectan en absoluto a la durabilidad del material. Los perfiles requieren muy poco mantenimiento. Basta con limpiarlos con agua templada y un jabón suave una o dos veces al año.

### ACERO INOXIDABLE

Aunque el acero inoxidable tiene su propia capa de óxido que lo protege de la oxidación, no deja de ser necesario eliminar regularmente la suciedad depositada en el acero con un paño seco y algún producto de limpieza especial para el acero inoxidable. Si la capa de óxido sufre algún daño, no siempre puede repararse por sí sola por completo. Un clima marítimo, el cloro, la lluvia ácida o un entorno urbano o industrial agresivo pueden dañar considerablemente el material. Estos factores determinan la frecuencia y la necesidad de limpiar la superficie. Generalmente resulta fácil encontrar los productos adecuados para ello. A pesar de todo, el acero únicamente se mantiene inoxidable si está cubierto por la capa de óxido. Por consiguiente, deberá evitar la formación de una capa permanente de suciedad, especialmente en el caso de factores ambientales agresivos.





## LANGUAGES

### ENGLISH P. 3

contents .....	p. 3
assembly extempore bench extra high .....	p. 4
assembly extempore table extra high .....	p. 5
assembly optional floor fastening .....	p. 6
maintenance .....	p. 8

### NEDERLANDS P. 11

inhoud .....	p. 11
montage extempore bank extra hoog .....	p. 12
montage extempore tafel extra hoog .....	p. 13
montage optionele grondverankering .....	p. 14
onderhoud .....	p. 16

### DEUTSCH P. 19

inhalt .....	p. 19
montage extempore bank extra hoch .....	p. 20
montage extempore tisch extra hoch .....	p. 21
montage optional bodenverankerung .....	p. 22
pflege .....	p. 24

### FRANÇAIS P. 27

contenu .....	p. 27
montage extempore banc haut .....	p. 28
montage extempore table extra haute .....	p. 29
montage ancrage au sol en option .....	p. 30
entretien .....	p. 32

### ITALIANO P. 35

contenuto .....	p. 35
montaggio extempore panca alta .....	p. 36
montaggio extempore tavolo extra alto .....	p. 37
montaggio ancoraggio al suolo opzionale .....	p. 38
manutenzione .....	p. 40

### ESPAÑOL P. 43

contenido .....	p. 43
montage extempore banco alto .....	p. 44
montage extempore mesa extra alta .....	p. 45
montage anclaje al suelo opcional .....	p. 46
mantenimiento .....	p. 48

## CONTENIDO

### BANCO ALTO

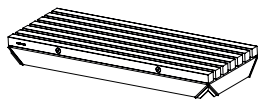

1 x banco



4 x pata



4 x barras de montaje

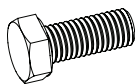

4 x tornillo M8x25



1 x acero inoxidable

---

### MESA EXTRA ALTA

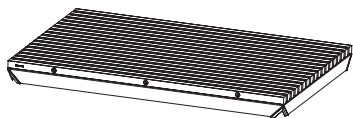

1 x mesa



4 x pata



4 x barras de montaje

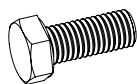

4 x tornillo M8x25

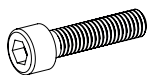

2 x tornillo M6x30



1 x escuadra de aluminio



2 x acero inoxidable

---

## OPCIONAL

### ANCLAJE AL SUELO



4 x eje inox

## MONTAJE EXTEMPORE BANCO ALTO

### UTENSILOS



2 personas



llave fija n° 13



llave macho hexagonal n° 4



+/- 15 min.

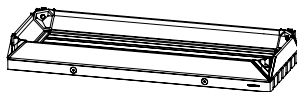

1. Coloque el banco en el suelo boca abajo (con la superficie de madera hacia el suelo). Use el material de embalaje como protección.

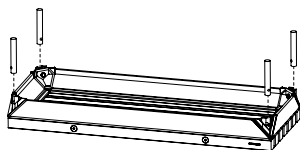

2. Inserte las 4 barras de montaje en los orificios correspondientes de las piezas angulares. Sujete las barras con los 4 tornillos usando una llave del n° 13. No apriete demasiado los tornillos, pues podrían partirse.

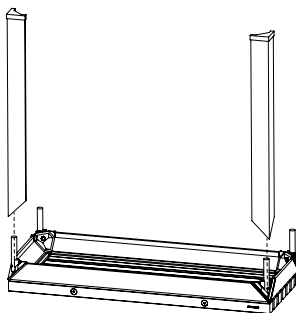

3. Coloque una pata, sin agujero, sobre el perno de acero inoxidable. Apriete los tornillos y repita para la otra escuadra en el mismo lado largo.

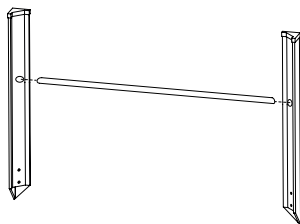

4. Coloque el tubo de acero inoxidable en los agujeros de las 2 demás patas.

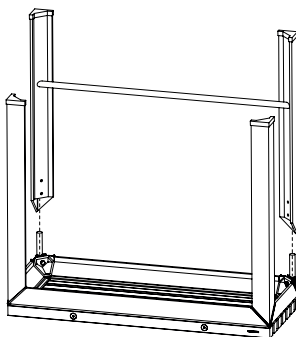

5. Coloque las patas sobre los pernos de acero inoxidable y fíjelas aprietando los tornillos. El banco está listo. Pongalo de pie.

## MONTAJE EXTEMPORE MESA EXTRA ALTO

### UTENSILOS



2 personas



llave fija nº 13



llave macho hexagonal nº 4



+/- 15 min.

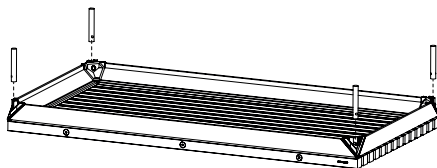

1. Coloque sobre de mesa en el suelo boca abajo (con la superficie de madera hacia el suelo). Use el material de embalaje como protección. Inserte las 4 barras de montaje en los orificios correspondientes de las piezas angulares. Sujete las barras con los 4 tornillos usando una llave del nº 13. No apriete demasiado los tornillos, pues podrían partirse.

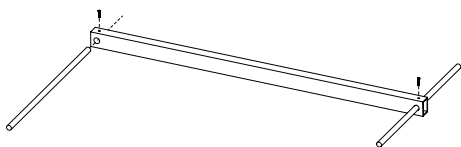

2. Tome el tubo de aluminio e introduzca una barra de acero inoxidable en el agujero en cada lado. Fije las barras de acero inoxidable con un tornillo M6 x 30.

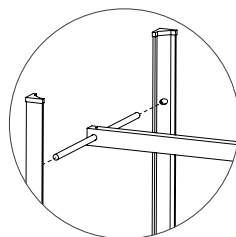

3. Tome 1 pata de izquierda e y derecho e introduzca la barra de acero inoxidable en los agujeros.

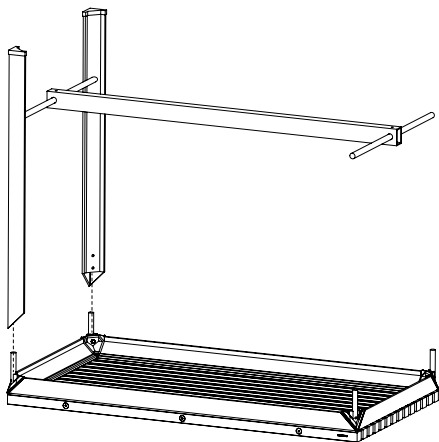

4. Coloque las patas juntas sobre los pernos de acero inoxidable de la mesa, como se muestra en la figura. Repita las 2 últimas operaciones para el otro.

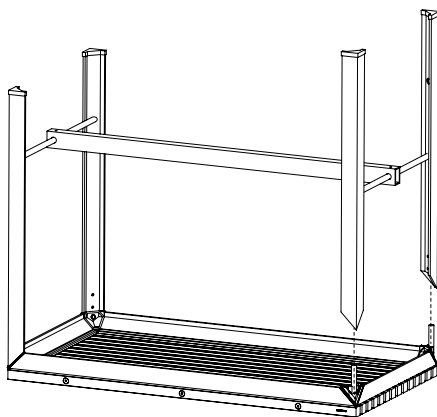

5. Fije los 4 patas aprietando los tornillos. La mesa está lista. Pongala de pie.

## ANCLAJE AL SUELO OPCIONAL

### UTENSILOS



2 personas



llave fija nº 13



llave macho hexagonal nº 4



+/- 15 min.

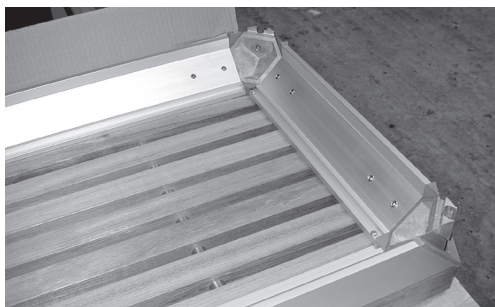

1. Coloque la banca o la mesa al revés en el suelo (con la parte de madera en el suelo) protegiendo la madera mediante el material de embalaje.



2. Coloque las 4 barras idénticas en los orificios hechos en los cuatro rincones.

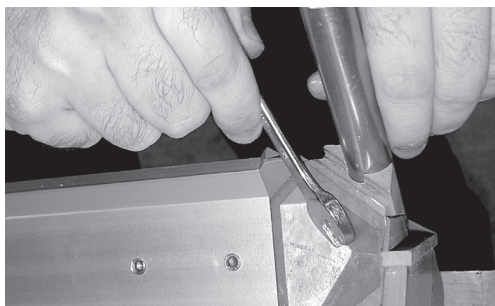

3. Atornille las barras mediante una llave fija de 13. Evite atornillarlas demasiado para que no se quiebren.

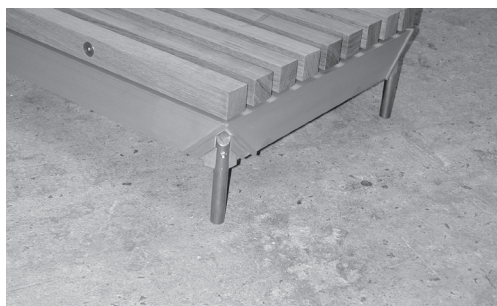

4. Coloque la mesa o la banca (sin sujetar las patas) en el sitio donde quiere fijar la banca o la mesa.



5. Indique donde las barras tocan el suelo. Desplace la banca o la mesa al terminarlo. Sujete las patas según las instrucciones en el manual Exttempore.



6. Haga agujeros mediante un taladro ( $\varnothing$  12 mm) en las indicaciones hechas en el suelo. Ajuste la profundidad de los agujeros al tamaño de los tacos entregados.



7. Sujete los ejes inox entregados mediante los tirafondos. Asegúrese de poner el eje inox recto.

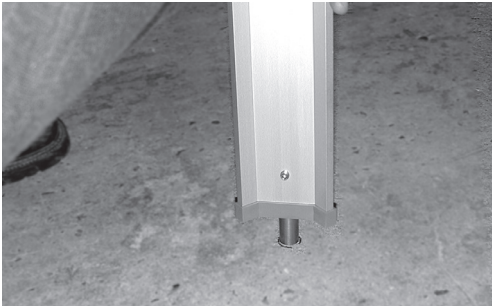

8. Ponga las patas de la mesa o de la banca sobre los ejes inox sobresa liendo del suelo.



9. Atornille los pequeños tornillos debajo de cada pata.

## MANTENIMIENTO

### JATOBA

La madera de Jatoba necesitan poco o ningún mantenimiento. Sin embargo, está fuertemente recomendado eliminar la suciedad persistente. Para limpiar la madera, puede emplear productos especiales ([www.rmc-extremis.be](http://www.rmc-extremis.be)) o simplemente un cepillo de cerdas duras y agua. Evite dañar irreparablemente las fibras de la madera. Por eso, **nunca emplee una manguera a presión**; la superficie lisa de la madera se puede volver áspera y puede dañar irreparablemente las fibras de la madera.

Al principio, la madera liberará un tinte rojo cada vez que entre en contacto con agua. El tinte que se pueda filtrar a la estructura o la superficie inferior sigue siendo soluble, por lo que desaparecerá por completo al cabo de cierto tiempo.

**Es fuertemente recomendado aceitar la madera para uso interior; así se evitan manchas.**

Las partes de madera de nuestros productos se suministran sin tratamiento. Expuestas al sol y a la lluvia, adquirirán una pátina gris plateada. Si quiere mantener más o menos el color original, trátelas con aceite una vez al año. Recomendamos emplear **RMC Hybrid Wood Protector** ([www.rmc-extremis.com](http://www.rmc-extremis.com)). Los productos para el tratamiento de madera RMC se venden en el mundo entero. Visite el sitio web [www.rmc-extremis.be](http://www.rmc-extremis.be) para buscar un revendedor cerca de usted.

### ¡¡¡IMPORTANTE!

La madera es un material vivo, por lo que, a pesar de la calidad superior de la Jatoba, se ve afectada por los cambios bruscos de temperatura y por la humedad. Como consecuencia de las tensiones internas provocadas por estas constantes adaptaciones, la madera se alabea. Entre otras cosas, este alabeo puede provocar la aparición de grietas. Asimismo, puede producirse cambios en el color y en la estructura. Dado que estas características son inherentes al material, quien lo elige debe aceptarlas.

Es posible lijar grietas a mano y con papel de lija, o con una lijadora. Para proteger las partes galvanizadas o pintadas, cubra los bordes con cinta de enmascarar muy robusta. Emplee papel de lija de grano 80 y empiece por el lado vertical del tablero. Mantenga la lijadora paralela al borde de la mesa. Lije ligeramente hasta que el borde sea plano. Ahora lije la parte superior. Cuide de mantener la lijadora paralela al tablero. No sólo trate la parte agrietada, pero todo el tablero. Esto asegura que el resultado es llano. Para evitar barbas, lije a mano el borde superior del tablero. Una vez eliminadas las barbas, puede tratar la mesa con aceite para madera dura, en función del efecto deseado.

### ALUMINIO

En nuestra gama «Ex Tempore» utilizamos perfiles de aluminio anodizado y extrudido. El anodizado es un proceso que consiste en incrementar el espesor de la capa de óxido de aluminio existente para evitar que el aluminio se oxide. Hemos optado por no someter el aluminio a ningún tratamiento adicional, pues éstos no alargan su vida útil y, en cambio, son muy perjudiciales para el medio ambiente. Por consiguiente, es posible que los perfiles presenten pequeñas rayadas o muescas, resultantes del proceso de producción, que no afectan en absoluto a la durabilidad del material. Los perfiles requieren muy poco mantenimiento. Basta con limpiarlos con agua templada y un jabón suave una o dos veces al año.

### ACERO INOXIDABLE

Aunque el acero inoxidable tiene su propia capa de óxido que lo protege de la oxidación, no deja de ser necesario eliminar regularmente la suciedad depositada en el acero con un paño seco y algún producto de limpieza especial para el acero inoxidable. Si la capa de óxido sufre algún daño, no siempre puede repararse por sí sola por completo. Un clima marítimo, el cloro, la lluvia ácida o un entorno urbano o industrial agresivo pueden dañar considerablemente el material. Estos factores determinan la frecuencia y la necesidad de limpiar la superficie. Generalmente resulta fácil encontrar los productos adecuados para ello. A pesar de todo, el acero únicamente se mantiene inoxidable si está cubierto por la capa de óxido. Por consiguiente, deberá evitar la formación de una capa permanente de suciedad, especialmente en el caso de factores ambientales agresivos.











Our headquarters:  
Couthoflaan 20b  
B-8972, Poperinge  
info@extremis.com  
+ 32 57 346020

[www.extremis.com](http://www.extremis.com)

Connect with us:



All rights reserved. Unless otherwise specified, all designs and photographs contained in this publication are copyright protected and are the property of Extremis. No part of this publication may be copied or distributed without Extremis' prior written consent. The names of the authors of photographs to which we do not hold rights are mentioned here. We have done our utmost to provide a comprehensive list of names. In the event of an alleged breach, please contact the editorial staff. © Extremis

20200123