

# Manille

© Design by Dirk Wynants for Extremis, 2023

extremis®



## Dimensions

The Manille is available in one dimension

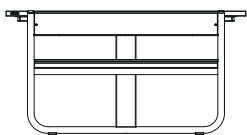
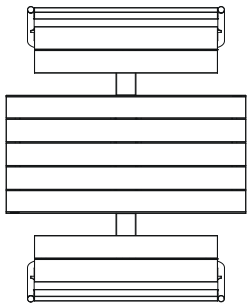

19.25

43.25

56.75

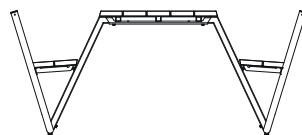

27.25

10.75

70.0



17.75

26.0

29.25

## Box dimensions

The Manille comes in 4 boxes

Box 1: Tabletop

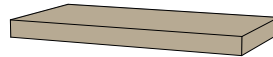

Box 2: benches



Box 3: Legs



Box 4: Backrests



Box dimensions (inch)		L	W	H	Qty	Volume (ft <sup>3</sup> )	Gross weight (lb)	Net weight (lb)	Packaging weight (lb)
Manille	Box 1	58.25	31.0	4.25	1	4.24	76.94	66.36	10.58
	Box 2	45.75	15.25	5.75	1	2.47	45.42	40.12	5.30
	Box 3	33.25	11.75	5.50	1	1.41	28.66	26.01	2.65
	Box 4	48.25	36.75	6.0	1	5.30	57.98	52.03	5.95
Total:						<b>13.42</b>	<b>209.0</b>	<b>184.52</b>	<b>24.48</b>

## Connection piece - Wood

The connection piece is available in one dimension

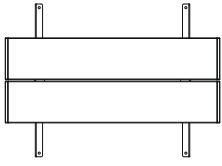

27.25

28.0



11.0

20.0

1.25 | 2.25

## Box dimensions

The connection piece comes in 1 box

Box 5: connection piece



Box dimensions (inch)		L	W	H	Qty	Volume (ft <sup>3</sup> )	Gross weight (lb)	Net weight (lb)	Packaging weight (lb)
Connection piece - Wood	Box 5	29.5	21.75	2.75	1	1.06	15.65	14.11	1.54

## Connection piece - Powder coated

The connection piece is available in one dimension



27.25

28.0



20.0

1.25 | 2.25

## Box dimensions

The connection piece comes in 1 box

Box 6: connection piece



Box dimensions (inch)		L	W	H	Qty	Volume (ft <sup>3</sup> )	Gross weight (lb)	Net weight (lb)	Packaging weight (lb)
Connection piece - Powder coated	Box 6	29.5	21.75	2.75	1	1.06	11.02	8.82	2.20

Multiple Manilles connected with connection pieces

Adding a connection piece and an extra table always results in a 68.25 in extension

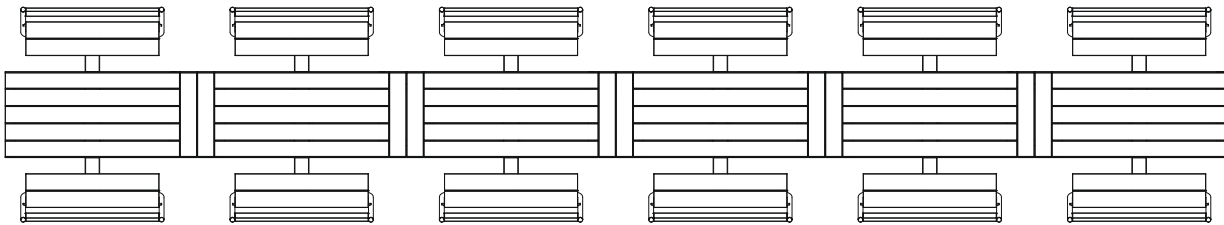

21.5

56.75

124.75

193.0

261.25

329.5

397.75

## Soft shade

The soft shade is available in one dimension

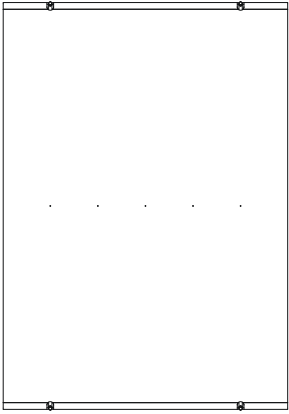

## Box dimensions

The soft shade comes in 1 tube

Box 7: Soft shade

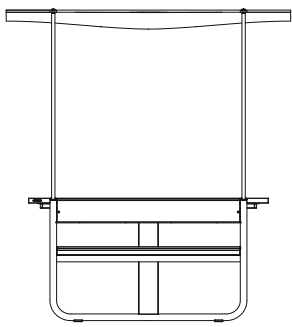

6.75

67.25

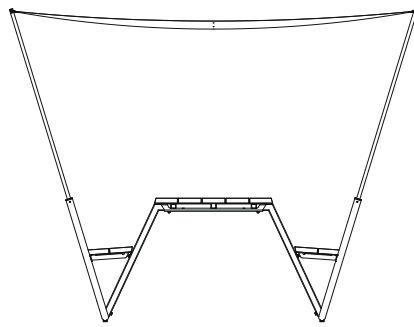

96.5

69.25

73.75

Box dimensions (inch)		L	W	H	Qty	Volume (ft <sup>3</sup> )	Gross weight (lb)	Net weight (lb)	Packaging weight (lb)
Shade	Box 7	78.75	4.25	4.25	1	0.71	19.84	15.43	4.41

Multiple Manilles with removable shade

Adding a Manille with removable shade always results in a 68.25 in extension

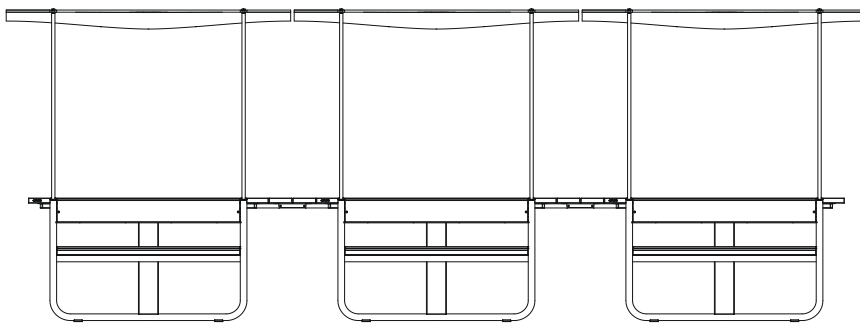

0.75

21.5

135.5

203.5

## Fixed shade

The fixed shade is available in one dimension  
The floor fastening is supplied (screws not included)

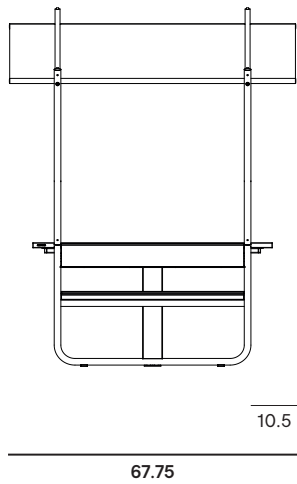
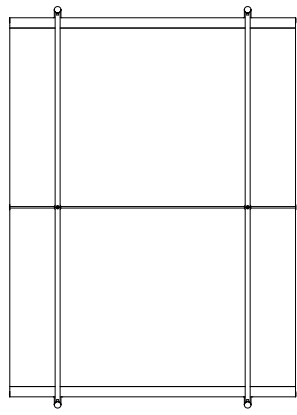

## Fixed shade box

The fixed shade comes in 1 tube

Box 8: Fixed shade

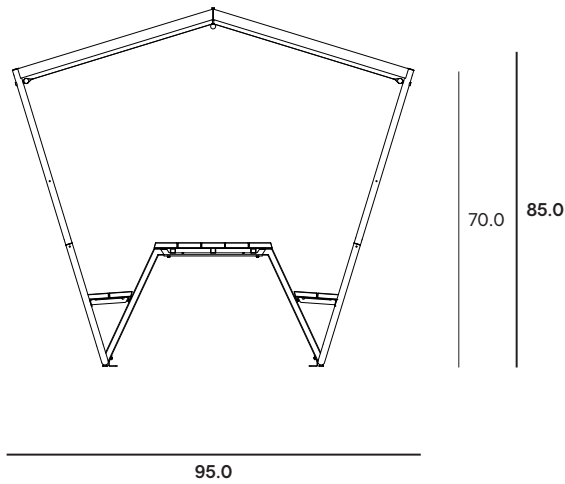
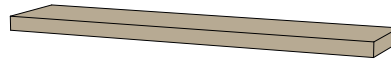

Box dimensions (inch)		L	W	H	Qty	Volume (ft <sup>3</sup> )	Gross weight (lb)	Net weight (lb)	Packaging weight (lb)
Fixed shade	Box 8	93.75	20.75	3.5	1	3.88	57.31	52.91	4.40

## Floor fastening

The floor fastening is available in one dimension

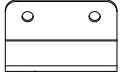

2.5

2.5

4.0

2.0



78.5

## Box dimensions

The floor fastening comes in 1 box

Box 9: floor fastening



Box dimensions (inch)		L	W	H	Qty	Volume (ft <sup>3</sup> )	Gross weight (lb)	Net weight (lb)	Packaging weight (lb)
Floor fastening	Box 9	6.25	4.75	4.25	1	0.35	1.39	1.17	0.22

# Wheelchair accessibility dimensions

As specifications for wheelchair accessibility vary around the world, please review the dimensions below to ensure the measurements of each solution meet the specifications of your local requirements

Accessible on both ends

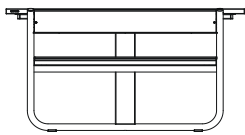
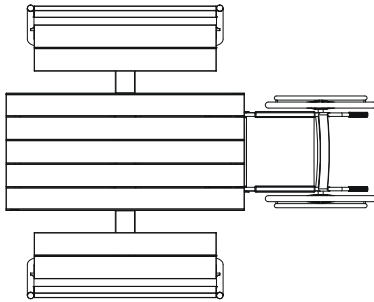

26.25

26.0

# Materials & colors

Check price list or [www.extremis.com](http://www.extremis.com) for current materials & colors

## Tabletop & benches



## Frame

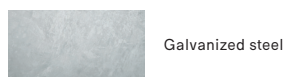

## Soft shade poles

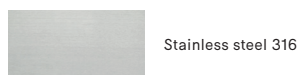

## Soft shade fabric

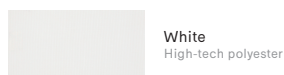

## Legs & fixed shade poles

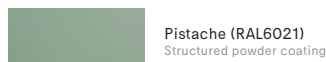
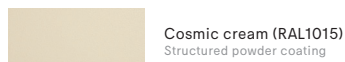
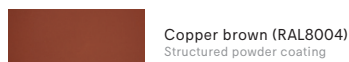
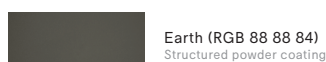

## Fixed shade fabric

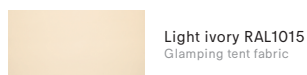

Materials	Key facts	Thickness inch	Layer thickness micron	Density	In/outdoor	Water	UV color fastness	Flame retarding
Hellwood tabletop & benches	 <ul style="list-style-type: none"> <li>• Durability CLASS 1</li> <li>• Carries the PEFC™ label for durable forestry</li> <li>• Feels comfortable in all weather conditions</li> <li>• Advisable to oil the wood</li> </ul>	1.18	n.a.	37 lb/ft <sup>3</sup>	Outdoor & indoor	n.a.	Untreated wood turns grey after a while	/
Hot dip galvanized steel frame	<ul style="list-style-type: none"> <li>• Most durable method for protecting metal from rusting</li> <li>• Protective layer</li> <li>• Very long life span</li> <li>• 100% recyclable</li> <li>• Cradle to Cradle Certified™</li> </ul>	0.10	50 - 100	0.47 10 <sup>3</sup> lb/ft <sup>3</sup>	Outdoor & indoor	n.a.	Very good, galvanization will however become less shiny when used outdoors	NEN-EN13501-1 A1 *
Structured powder coated stainless steel legs	<ul style="list-style-type: none"> <li>• Easy to clean</li> <li>• Stainless steel (for protection against rust), then powder coated</li> <li>• More scratch-resistant than non structured powder coated</li> </ul>	0.07 - 0.31	80	0.50 10 <sup>3</sup> lb/ft <sup>3</sup>	Outdoor & indoor	n.a.	Very good: color can fade to some extent when exposed to UV	NEN-EN13501-1 A1 *
High-tech polyester fabric (soft shade)	<ul style="list-style-type: none"> <li>• Excellent resistance to marine environments</li> <li>• Excellent tear strength and dimensional stability</li> <li>• Easy upkeep with soapy water or Cleaner 500</li> <li>• Up to 28% natural light transmission</li> </ul>	0.02	n.a.	13.4 oz/ft <sup>2</sup>	Outdoor & indoor	n.a.	Very good: Elab < 3 UVA 340 / 2000h***	M2 & B1
Stainless steel poles (soft shade)	<ul style="list-style-type: none"> <li>• High rusting resistance</li> <li>• Periodical maintenance required</li> </ul>	0.07	n.a.	0.50 10 <sup>3</sup> lb/ft <sup>3</sup>	Outdoor & indoor	n.a.	Very good	NEN-EN13501-1 A1 *
Glamping tent fabric (fixed shade)	<ul style="list-style-type: none"> <li>• Deluxe dull embossing</li> <li>• Effortless maintenance</li> <li>• UV resistant and flame retardant</li> <li>• Super Opaque</li> </ul>	0.02	n.a.	23 oz/ft <sup>2</sup>	Outdoor & indoor		7/8 (ISO 105-B02)	M2 & B1

### NEN-EN13501-1 A1

Class A1 products will not contribute to fire in any stage, including fully developed fire. For this reason, they are assumed to be capable of satisfying all requirements of all lower classes as well.

## Good to know

- PEFC™ certified wood originates from sustainably managed forests.
- We strongly recommend using floor fastening when combining Manille with the fixed shade
- A configuration of six Manilles with connection pieces fits on a high cube pallet.

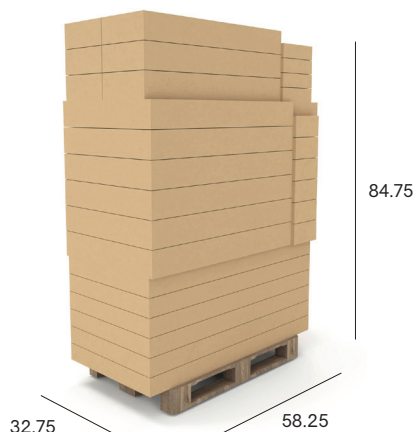

## Wheelchair accessible

Manille is wheelchair accessible on both ends of the table.



## Certificates

- PEFC
- Cradle to Cradle
- BIFMA (Desk and Table Products / Lounge and Public Seating)

## Maintenance

### POWDER COATED PARTS

- Use Extremis multi cleaner, a 100% biodegradable detergent or common kitchen cleaning products. Avoid using aggressive products. These surfaces are best cleaned with a neutral cleaning product diluted in water.

### GALVANIZED PARTS

- Clean with lukewarm water and a mild detergent or Extremis multi cleaner.

### WOOD

- Clean regularly with mild detergent.
- Thorough cleaning with Extremis Wood Cleaner.
- Oil the wood with Extremis Wood Protector. We recommend oiling the wood at regular intervals depending from location and general weather conditions.
- In order to smoothen the surface again after a thorough cleaning, lightly sand your wood with 120 grit sanding paper or a sanding pad.

### RECOMMENDED USE

- For Extremis Wood protector:

		
2 to 3 wood care treatments	1 wood care treatment	450 - 500 ml for one Manille

### PARASOL FABRICS

- Use Extremis multi cleaner, a 100% biodegradable detergent or common kitchen cleaning products. Avoid using aggressive products. These surfaces are best cleaned with a neutral cleaning product diluted in water.

### STAINLESS STEEL

- Clean regularly with a dry cloth and some stainless steel cleaner.

## F.A.Q.

Q: Do you need to oil the wood?

A: Just like other types of wood, wood will gradually become rougher and start to turn grey as a consequence of exposure to the sun and rain. Small cracks and crevices can also appear as part of this process. We strongly advise everyone to treat the furniture with our Wood Protector. This 100% natural oil controls the moisture level within the wood, which makes the planks stay stable for longer, and the layer of oil also helps to prevent spilled liquids from being absorbed, so that stains tend to stay superficial. It is best to repeat this treatment at regular intervals.

## Warnings

### General

- Do not use any sharp tools to open the packaging.
- We strongly advise against using power tools.
- Tripping hazard, mind your step.
- Do not put out cigarettes on the table.
- Not graffiti proof.
- Do not leave children unattended whilst playing on the table.
- To avoid danger of suffocation, keep plastic bags away from babies and children.
- Colors can differ over years and from batch to batch.

### Product

- Do not stand or jump on the table.
- Do not drag the table, but carry it with minimum 2 people.
- Max. 2 people or 661 lb per bench.

### Wood

- When delivered, the wood is untreated.
- Wood is a natural material and its look is different for every slat, plank and tree.
- Wood will gradually become rougher and start to turn grey as a consequence of exposure to the sun and rain. We recommend oiling the wood at regular intervals depending from location and general weather conditions.
- Clean regularly with mild detergent. Never use

a high pressure cleaner as this will roughen the wood's smooth surface and irreparably damage the wood's fiber.

- Thorough cleaning with Extremis Wood Cleaner.
- We strongly recommend that you treat your wood with wood protector to protect it from stains - small cracks and crevices can also appear as part of this process. We strongly advise everyone to treat the furniture with our Wood Protector.

### Powder coating

- White powder coating requires more maintenance.
- Do not use abrasive scouring powders or scourers as they will scratch the surface.
- Color can fade to some extent when exposed to UV.
- Flame retarding - NEN-EN13501-1 A2-sl - Satisfying the same criteria as Class B for the SBI-test according to EN13823. In addition, under conditions of a fully developed fire these products will not significantly contribute to the fire load and fire growth.
- Dark colors can get very hot in sunny weather.

### Galvanized steel

- Galvanization will become less shiny when used outdoors.
- Flame retarding - NEN-EN13501-1 A1 - Class A1 products will not contribute to fire in any stage, including fully developed fire. For this reason,

they are assumed to be capable of satisfying all requirements of all lower classes as well.

- Possible impurities in the immersion tank can cause black marks during galvanization, which are intrinsic to this industrial finishing technique.
- White marks on this zinc layer are also intrinsic to this procedure and will disappear when the furniture is put outdoors.
- This industrial finishing technique may result in a rougher surface. This is intrinsic to the process.

### High-tech polyester

- We advise to clean frequently.
- Keep in mind that white is a more sensitive color.

### Stainless steel

- Very good UV color fastness.
- Flame retarding: NEN-EN13501-1 A1 - Class A1 products will not contribute to fire in any stage, including fully developed fire. For this reason, they are assumed to be capable of satisfying all requirements of all lower classes as well.
- Watch out, stainless steel isn't entirely rustproof! Be sure to avoid contact with iron objects. If it does show signs of rust, clean with rust remover as quickly as possible.

The content of this document, in particular the mentioned models, is protected by copyrights and/or design rights. The present document and its content is communicated to you for information purposes only. Any partial or total reproduction or any other use without our prior written permission is strictly prohibited. This technical sheet remains subject to possible changes. All dimensions are in inch, unless mentioned otherwise. Extremis is not responsible for the errors in the documentation of products. All measurements are approximate and are provided for informational purposes only.

**Tech  
sheet**

20250206